

APRIL  
1975

THIRTY PENCE

Vol. XXXIII  
No. 2

THE  
**SHORT  
WAVE**  
MAGAZINE

**WORLD WIDE  
COMMUNICATION**

**FOR THE RADIO AMATEUR AND AMATEUR RADIO**

# STOP mistreating your rig

Match your antenna system to the PA stage with a KW 107—observe your TX "Waveform" with a KW 108.

#### KW 108 Monitorscope

- Monitor your transmitted "Waveform" 10-160 metres.
- Can be left permanently in antenna feed.
- Two-tone generator incorporated to ensure optimum linearity for SSB.
- Displays SSB, AM and CW "Waveform."
- A further safeguard for your PA tubes.



**KW 108  
Monitorscope**



**KW 107  
Antenna Tuning System**

#### KW 107 ANTENNA TUNING SYSTEM

The KW range of aerial matching units will ensure optimum power transfer from the PA stage to the antenna system.

- Longer life for your PA tubes.
- KW 107, suitable for most transceivers and transmitters (250 watt rating).
- The KW 109 is for use with linear amplifiers.
- Antenna selection.
- RF power and SWR measurement.
- Dummy load incorporated.
- Observation of SWR with and without antenna tuner.
- Attractive "G" line case.

The antenna tuner in the above unit can be purchased separately if you already have the KW 101/103, dummy load and antenna switch. This unit is known as the KW E-Z match.

Write or 'phone for catalogue to:



## Communications Products

**(Decca Communications Ltd)**

1 Heath Street, Dartford, Kent Tel: Dartford 25574/21919

Easy terms on Equipment available over 12, 18 or 24 months.

**Other KW Favourites:** KW 2000E Transceiver 10-160; KW 204 Transmitter; KW 1000 Linear Amplifier; KW 202 Receiver; KW 160 ATU; KW 103 SWR/RF Power meter; KW Dummy Load; KW Traps (the original and best); KW Trap Dipoles; KW Low Pass Filter; KW Balun; KW Antenna Switch

Stockists for Hy-Gain beams and verticals, CDR rotators. Shure microphones, etc.

**KW spares are normally carried for a minimum of five years after date of manufacture of equipment.**

there is a social evening with wives and girl-friends. It should be mentioned that G3MDW conducts all his activities from a wheelchair.

Wakefield have a regular booking at the Youth Centre, Ings Road. For April, the dates are April 15 when they have an AGM, and April 29—this latter has the intriguing title of "See How they Run" and the exact details are a closely-guarded secret of G3WWF, the only clue being that it will be, at least loosely, connected in some way with radio! Be there to find out!

Hull also have a connection with Ings, in the address of their secretary, G8GDD—see Panel. One wonders to what it refers, as Hull and Wakefield are by no means near neighbours. However, to business. The Hull group Hq. is at 592 Hessele Road, and here they have, on April 4, a talk by G8IED on Easy Test Equipment. G3PQY takes over for the 11th, to talk about the "Elements of Condensers"—no doubt these are for turning steam into water! Back to G8IED on April 18 for a talk on Electro-plating, and on April 25 the activity known as VLF (Very Low Frequency communication) will be explained by G3WWD.

Up at York the lads have been doing quite a bit in the way of extra-mural activities, the latest being a trip to the theatre to see G2DQU, Brian Rix, perform. For the current detail we have to refer you to G3WVO, see Panel, albeit the letterhead tells us that the venue is at the British Legion Club, 61 Micklegate.

The main item for April at the Star Club in Leeds is on April 16, and is a Junk Sale, but they foregather every Wednesday evening at the New Inn Hotel, Bramley Town Street, Bramley, Leeds 13.

By the time this comes to be read the West of Scotland group will have ceased to be able to use their normal Hq. This being the case, before any attempt is made to go to any of their meetings, a contact should be made either with Graham Bleakley on *Cumberland* 26922, or GM3RHR, *QTHR*, the hon. secretary, on 772 3085.

#### Down South

A good start would be to pick up the Cray Valley note—from which we see they have the usual first and third Thursday routine at Eltham United Reformed Church Hall, 1 Court Road, Eltham, London S.E.9; this gives April 3 for the Annual General Meeting and the 17th for an Informal.

A crew who rarely if ever miss our 'bus as far as publicity goes are Yerulam, who entertain G4CLF of Plessey on April 16, at the Market Hall, St. Albans.

British Red Cross Hall, The Crescent, is where the Maidenhead group get together. On April 3 they have a panel on Operating Procedures and on the 15th G3DOJ will be talking about Simple Receivers and Converters.

At Acton, Brentford and Chiswick they have G3CCD discussing the first part of a Digital Frequency Meter he has designed. This is on April 15 at 66 High Road, Chiswick.

One is surprised by the *Crystal Palace Newsletter* this month—for the first time your conductor can remember Secretary G3FZL says that the detail for April 19 is "to be announced." Nonetheless, we know the date, and the venue is, as always, Emmanuel Church Hall, Barry Road, London S.E.22.

Bishops Stortford will be getting together as usual on April 21, at the British Legion in Windhill, but the detail is not yet available.

On to Southgate where our current issue of the *Newsletter* is pretty well behind with the news(!) giving as it does the January and February dates. Not to worry though, as it also says that there is a regular routine, namely to assemble at the Scout Hut in Wilson Street, Winchmore Hill Green. Any more details which may be wanted can be obtained by contacting G4AEZ, as Panel.

Bedford's secretary has been away from home for a while and so got a bit out of routine; but he didn't forget, which is the main thing, so we can say that it is a weekly get-together, each Thursday evening in the United Services Club, on The Broadway.

\* \* \*

For Silverthorn, the current *Newsletter* is on a historical kick at the moment thanks to material from G2HR—how many of you readers could draw a Flewelling circuit or even say what it was used for? This old scribe could! They get together on a weekly basis at Friday Hill House, Simmons Lane, Chingford, the shack being inside the tower, with the two-metre aerial and rotator on top. Friday evenings are the ones to keep clear in your diary, and G4AJA (as Panel) should be contacted for the very latest gen.

There are plenty of things going on at Barking: on Mondays to Thursdays in each week the Hq. is open, at Westbury Recreation Centre, Westbury School, Ripple Road. Mondays for construction, Tuesdays for Morse tuition, Wednesdays for the Club station, and

the meeting proper on Thursdays. This suggests a nicely-balanced programme.

April 22 is the AGM date for Sutton & Cheam, the venue being the Library, Cheam; in addition we hear they are thinking of running an informal session during April, which is something that G4BOX, see Panel, can no doubt explain if you contact him.

North Kent folk please note: The group has changed Hq. and is now to be found at St. Mary's Institute, 2 North Cray Road, Bexley, right opposite St. Mary's Church on the bend of the road; it is a converted house with the front door right on to the pavement. Get into Bexley village, bear left in the village and almost immediately right again into the public car park. The Hq. is a couple of hundred yards away, past the garage and the Old Mill restaurant. The change of Hq. has not made any changes needful in the routine, which is still to get together on the second and fourth Thursdays of the month.

Reigate have their AGM on April 29 at St. Mark's Church Hall, Alma Road. This preceded on April 1 by the informal at the "Marquis of Granby," Hooley Lane, Redhill, and the annual dinner and dance on the 11th. Further details on any of these can be obtained by getting in touch with the Secretary—see Panel.

Thames Valley is the ambitious title of the group based in the Hampton Court area, the venue being the small room at King George V Hall, Portsmouth Road, Esher, and the date the first Wednesday in every month; April's subject is Printed Circuits, by G3JJP.

For Chiltern we see the dates are to be April 1 for the Informal, and April 23, for which a programme was being arranged at the time they wrote. The venue is the canteen of the Ernest Turner works in Totteridge Road; visitors are asked to use the Works car park, which is specially opened up for the meetings and has its entrance in Gordon Road.

\* \* \*

April 3 and 17 are the dates for Stevenage, at the Hawker Siddeley Dynamics Works, nothing being said about a programme which this old scribe knows is in the makings. But there is an intention to run a trip to the Drayton Manor Rally "for a lot of goodies," as their scribe has it.

You can't go much further south than Southdown without swimming. They having their Hq. at the Victoria Hotel, Latimer Road, Eastbourne, on the first Monday in each month—for April G8CVV and G8CFZ will tackle the question of Aerials and Propagation. A look forward to May shows them to be running the Annual Junk Sale.

Surrey look to have the third Tuesday as their regular date at the "Ship Inn," High Street, Croydon, and April turns out to be the most important of the year, namely the AGM. Don't miss it!

"Still booming" says Maidstone YMCA's secretary, G4BNI, his beginners' class now having been augmented by a couple of YL's; and the meeting turnouts are up, too. For the April 4 meeting, the subject is SS/TV, starting at 8.30 p.m. On the 11th there is the usual Beginners' Evening under G3XUN, and on the 18th a discussion on the Club Mobile Rally takes up all evening; and on the 25th, G3XUN and his beginners have the limelight again. Venue is Maidstone "Y" Sports Centre, Melrose Close.

\* \* \*

Weekly is also the situation at Harrow, in the Sea Cadets Hq., Woodlands Road, Harrow. G3HB will be talking about Awards on April 4, and April 25 is down for G2UV to discuss "The Sounds of the Twenties," which should be of considerable interest; the other two evenings, April 11 and 25, are both Practicals.

After "dropping off" a bit recently, the latest *Echelford Newsletter* is right back in form, with a bit of technical stuff, a bit of controversy, and very easy-to-read print. Right at the top of page 1 is the place to look for the details—second Monday and last Thursday in each month, the Hq. being at St. Martins Court, Kingston Crescent, Ashford, Middx. April 14 is a Surplus Sale, and on April 24 a representative of Hewlett-Packard is coming along to talk about Opto-Electronics. It makes the mind boggle!

#### Late Ones—And Deadlines

Because of pressure on space and the tight production schedule to which we have to work, it is just not possible to write in Club reports received after the deadline we give each month, always set to the latest we can accept.

Yet month after month, we could list Club secretaries who send in reports, marked "Urgent," or "For immediate attention, please," or "Sorry, I was not able to post sooner"—in the hope and in the supposition by so saying their offering could escape the net and be written in at the last moment. It can't be. The Deadline is the Dead-

line. Even this is being written just as the machines begin to turn "tomorrow morning."

The deadline for the next issue of "Month With The Clubs" is Thursday, April 3. For the next it is May 8. Address to: "Club Secretary," *SHORT WAVE MAGAZINE*, BUCKINGHAM, MK18 1RQ. See you next month and we hope on time.

For this month's Reader Small Advertisements, see pp. 112-118

## NEW QTH'S

EI1CT, T. J. O'Gorman, Ivy Villa, Borris, Co. Carlow, Eire.  
 G4DHE, A. Henry, 27 Longworth Avenue, Ceppull, Chorley, Lancs., PR7 4PJ.  
 G4DHF, D. Johnson (ex-G8HAE), 3 Ethelstone Road, Grimsby (55354), South Humberside.  
 G4DMU, Dr. T. G. Scott, Keeper's Cottage, Cot Road, Illogan, Redruth, Cornwall.  
 G4DMV, Miss K. H. Scott, Keeper's Cottage, Cot Road, Illogan, Redruth, Cornwall.  
 G4DNE, G. F. D. Swaysland (ex-G8HWR), 11 The Square, Boothfold, Waterfoot, Rossendale, Lancs., BB4 9BD.  
 G4DOG, T. H. H. Illingworth, 7 St. Anns Crescent, Carlisle, Cumbria, CA3 8QA.  
 GM4DOZ, T. Findlay, 8 Middlefield Drive, Muirkirk, Ayrshire, KA18 3RP.  
 G4DPL, R. G. Gleave, 2A Cecil Avenue, Skegness, Lincs., PE25 2BX.  
 G4DFP, P. J. Slade, 65 Hurley Road, Greenford, Greater London, UB6 9HA.  
 G4DRT, D. A. Rhind-Tutt (ex-G8FBH), 203 Western Avenue, London, W3 6RL.  
 G4DSD, R. Woodman, 1 Shirley Gardens, Sunderland, Tyne & Wear, SR3 1YD.  
 G4DSQ, R. C. Coombe, 21 Glenmore Road, Stockport, Greater Manchester, SK1 4ED.  
 G4DSR, B. Irwin, 95 Turncroft Lane, Stockport, Greater Manchester, SK1 4AR.  
 G4DTB, M. Bryan (ex-G8IMG), 127 Leadbury Road, Hereford (4971), HR1 1RQ.  
 GM4DTH, P. J. Dick (ex-GM8HHC), 89 Trinity Road, Edinburgh, EH5 3JX.  
 G4DTV, R. W. Holland, 90 Brook View Drive, Keyworth (5458), Nottingham, NG12 5RA.  
 G4DUD, F. Hutchinson (ex-G8CBW), 195 Washington Road, Lansdowne, Sheffield (734144), South Yorkshire, S11 8DQ.  
 GM4DVG, J. N. Douglas (ex-GM8EUS), 49 Barcalaine Avenue, Chryston, Glasgow, G69 9PB...  
 G4DVR, J. J. Life, 78 Elmstead Gardens, Worcester Park, Surrey, KT4 7BE.  
 G4DVV, A. E. Lake, 7 Middleton Close, Nuthall, Nottingham. (Tel: 0607-43 2509.)  
 GM8CMV, J. J. Creedy (ex-G8CMY), 4 Abbotsford Place, St. Andrews (3349), Fife.

This space is for the publication of the addresses of holders of new callsigns, or changes of address, in EI, G, GC, GD, GI, GM and GW of stations not already listed. All addresses published here will appear in the U.K. section of the American "CALL BOOK" in preparation. Please write clearly and address on a separate slip to QTH Section. Be sure to give correct County designation and post-code. Address items for this space to: "New QTH Page," *SHORT WAVE MAGAZINE*, BUCKINGHAM, MK18 1RQ.

G8ISU, N. Whittingham, 7 Ridgedale Mount, Pontefract (72784), West Yorkshire, WF8 1SB.  
 G8IYL, N. W. Smith, 87 Lancaster Road, Ashby, Scunthorpe, South Humberside.  
 G8JMO, D. J. Robinson, 3 Springfield Road, Attleborough. Nuneaton, Warwicks., CV11 4PY.  
 G8JNF, I. D. Berry, 8 Sherwood Grove, Leigh Lancs., WN7 3AZ.  
 G8JOK, D. E. Barwood, 41 Wingfield Road, Knowle, Bristol 3, Avon, BR5 5EG.  
 G8JPR, F. Corcoran, 49 Collingwood Crescent, Newtownabbey, Co. Antrim, Northern Ireland.  
 GM8JPT, K. Turner, 31 Niddrie Road, Edinburgh. EH15 3NZ. (Tel: 031-609 3363.)  
 G8JQD, S. D. Northam, Little Orchard, Broadclyst, Nr. Exeter, Devon.  
 G8JRM, P. Hughes, 1 Entwistle Grove, Leigh, Lancashire, WN7 3DQ.  
 G8JRX, A. Mills, 42 Mora Avenue, Chadderton, Oldham, Lancs., OL9 0EJ. (Tel: 061-620 3108.)  
 G8JSA, C. F. Phillips, 18 Birdlip Grove, Quinton, Birmingham, West Midlands, B32 1ER. (Tel: 021-422 4217.)  
 G8JSW, W. J. Wellington, 57 Hillcrest, Monkseaton, Whitley Bay, Tyne & Wear, NE25 9AF.  
 GM8JUY, R. S. McMillan, Cairnbaan, 64 Eglinton Street, Coatbridge, Lanarks., ML5 3JF.  
 G8JXB, G. E. Mayo, 117 Tamworth Road, Kingsbury, Tamworth, Staffs., B78 2HH.  
 G8KCE, V. D. Cunningham, 28 Star Road, Peterborough, Cambs., PE1 5HP.

G3GSO, T. W. Bryan, 13 Scarsdale Avenue, Allestree, Derby, DE3 2LA.  
 G13JLA, A. E. Latham, 9 Thornville Park Omagh, Co. Tyrone.  
 G3TSG, M. J. Grierson, Officers' Mess, R.A.F. Station Henlow, Beds.  
 G3TVS, Thames Valley Amateur Radio Transmitters Society, c/o V. Brand, G3JNB, 17 Southwood Gardens, Hinchley Wood, Esher, Surrey.  
 G3VEB, A. R. Matthews, 30 Ashchurch Grove, London, W12 9BU.  
 G3VLX, D. Buckley, 16 Wood Ride, Petts Wood, Orpington, Kent.  
 G3VWL, R. E. Kemp, 9 Newtimber Avenue, Goring-by-Sea, Worthing, Sussex.  
 G3WDL, T. F. Weatherley, 16 Beverley Court, Carlton Colville, Lowestoft, Suffolk.  
 G3WNG, J. E. Grigsby (ex-V56DB), 8 Robertson Road, Catterick Garrison, North Yorkshire.  
 G3XYZ, G. Bedwell, Wychwood, Forest Row, Wokingham, Berks., RG11 1HY.  
 G3ZPN, J. V. Gibson, 56 Hull Road, Withernsea, North Humberside, HU19 2EQ.  
 G4A1Q, G. J. Mitchell, Fosse Farm, Fen Road, Stickford, Boston, Lincs., PE22 8HA.  
 GW4BLE, S. Cole, 25 Fernlea, Risca, Gwent, NP1 9FW.  
 G4BYG, V. Lindgren, 27 Cedar Wood, Gilberdyke, Brough, North Humberside, HU15 2TZ.  
 GM4CKP, W. M. MacDonald, Tigh-na-Bruach, 23 Elenfield, Carnock, Dunfermline, Fife.  
 G4CXM, R. P. James, 264 Fishponds Road, Fishponds, Bristol, Avon.  
 G4CXQ, D. L. Dyer, Damir, 24 Treliске Road, Roseland Gardens, Redruth (4886), Cornwall.  
 G4HZ, E. C. W. Beale, Netheredge, 43 Gaddum Road, Bowdon, Altrincham, Cheshire, WA14 3PQ.  
 G8BQO, W. G. Taylor, 28 Foster Street, Chorley, Lancs., PR6 0AY.  
 G8EZH, M. A. Smith, 21 Lakelands Close, Hampden Park, Eastbourne, Sussex, BN22 9EH.  
 G8FPN, J. F. Williams, 54 Granville Drive, Kingswinford, Brierley Hill, Staffs.  
 GW8GRA, N. R. Atkins, Brynglas, Trefeglywd, Nr. Caersws, Powys, SY17 5QE.  
 G8HED, I. S. Camm, 6 Maيدا Vale, Anchorsholme, Cleveleys, Lancs.  
 G8HSZ, J. W. Redfean, 24 Penwerris Terrace, Falmouth, Cornwall.  
 G8IMP, M. Connah, 37 Lismore Road, Highworth, Wiltshire, SN6 7HU.  
 G8ISV, C. E. Davies (E8BL, G3HNM), 189 Straid Road, Bushmills, Co. Antrim.

## CHANGES OF ADDRESS

EI4BK, T. Deegan, 27 Oakland Drive, Greystones, Limerick, Eire.  
 G2BUL, G. L. Butler, 130 Coulsdon Road, Old Coulsdon, Surrey, CR3 2LE.  
 GW3COL, J. Worthington (ex-G3COT) Penrhyn Bach, Bwlch Tocyn, Pwllheli Caerns.

# STOP!

**Are you interested in buying top performance VHF or UHF equipment? Then look no further! . . .**

## 144MHz Mosfet Converters

We offer the only professionally specified converter for use with modern highly accurate 28-30 MHz receivers. We have now standardised the design of our 28-30 MHz converter using a zener-stabilised 116 MHz crystal oscillator, giving a typical read-out error of better than 1 kHz. The converter is now available in the two versions, with and without the local oscillator output facility.

**MMC 144/28** Price **£16.42** inc. VAT

**MMCI44/28 LO** (with 116 MHz output) Price **£17.60** inc. VAT

### SPECIFICATION

Noise figure : 2.8 dB max. Gain 27 dB typ.  
Image rejection : 65 dB typ.  
Crystal oscillator : 116 MHz (zenered)  
Frequency error at 144 MHz : 3 kHz max.  
Power supply : 35mA at 12 volts.  
116 MHz o/p power : 5mW min (LO o/p version)

We have extended our popular range of single conversion converters to include the following I.F.s :

9-11, 12-14, 14-16, 18-20, 24-26, 27.7-29.7, 28-30 MHz.  
Price **£16.42** inc. VAT

## 144 MHz DOUBLE CONVERSION MOSFET CONVERTER

I.F.s available ex-stock : 2-4, 4-6 MHz. Price inc. VAT **£16.42**  
This unit was developed to meet the heavy demand for a converter suitable for use with receivers having better performance at lower frequencies. It uses two dual-gate mosfet mixers, both fed from the output of a 70 or 71 MHz crystal oscillator. Selectivity is obtained at the first IF in the 74 MHz range, thereby overcoming the usual problems associated with low-I.F. single conversion converters.

## 70 MHz MOSFET CONVERTERS

I.F.s available : 4-4.7, 14-14.7, 18-18.7, 28-28.7 MHz.  
Price **£16.42** inc. VAT

## 144 MHz DUAL OUTPUT PREAMPLIFIER

This two-stage mosfet preamplifier has two separate isolated outputs, for feeding two receivers, for example. The gain is 18dB, and the noise figure is 2.8dB. The noise figure is individually optimised on each unit using our new automatic noise measuring equipment.  
Price inc. VAT **£9.72**

## 432 MHz MOSFET CONVERTER

I.F.s available ex-stock : 14-16, 18-20, 24-26, 28-30, 144-146 MHz.  
Price inc. VAT **£19.55**

This unit uses a dual-gate mosfet mixer for excellent strong-signal performance preceded by two BFY90 transistor RF stages for high sensitivity. All UHF tuned circuits are printed using Microstrip technology, and a crystal in the 100 MHz region is used in the oscillator chain to overcome unwanted beats in the tuning range.

## 1296 MHz CONVERTER

This converter has been developed using an extension of the microstrip techniques that have been well proven in our 70 cm. converter design. Two versions of the design are available using either a 96 MHz or 105.666 MHz crystal to produce I.F.s or 144-146 MHz or 28-30 MHz respectively, corresponding to the 1296-1298 MHz band. We are using crystals of a very tight tolerance to minimize the offset that would otherwise be very noticeable when using a high performance 28-30 MHz tunable receiver. The multiplier chain uses three BFY 90 transistors and the mixer is fabricated using a pair of MA 4882 Schottky diodes in a balanced hybrid ring configuration. The I.F. head amplifier uses selected low noise dual-gate mosfet to give an overall noise figure which is typically better than 8.5dB, and a gain of 25dB. Microstrip UHF circuitry ensures repeatability of this high performance design. The unit is housed in the same small die-cast box as the rest of our range of converters and is fitted with 50 ohm BNC connectors for optimum UHF performance. The converter operates from a nominal 12v. supply and is available in negative earth version only.  
Price inc. VAT **£25.92**

## VARIABLE TRIPLERS

We manufacture varactor triplers for 432 and 1296 MHz. Both are highly stable, with low level harmonic output, and capable of AM operation at the 50% power level. These units are aligned using swept-frequency and swept-power drive sources, the output of each unit being monitored on one of our spectrum analysers. Great attention is paid to harmonic suppression and linearity. All harmonics are greater than 40 dB down on the wanted output.

## 432 MHz VARIABLE TRIPLER

Maximum input power at 144 MHz: 20 watts. Typical output power (at maximum input): 14 watts. Price inc. VAT **£18.90**

## 1296 MHz VARIABLE TRIPLER

Maximum input power at 432 MHz: 24 watts. Typical output power (at minimum input): 14 watts. Price inc. VAT **£27.00**

## 136 MHz SATELLITE BAND CONVERTER

I.F.s available : 28-30 MHz and others. Price inc. VAT **£16.42**

★ **Terms :** Cash or cheque with order, or by Giro Transfer to our account, No. 683 4159.

★ **Delivery :** Ex-stock by return of post.

★ All units available from us ex-stock post free.

★ Our equipment available through all amateur radio retailers.

★ All equipment fully guaranteed for 12 months.

★ Full details available on receipt of s.a.e.

# MICROWAVE MODULES LIMITED

11 CRANMORE AVE., CROSBY, LIVERPOOL L23 0QD Tel: 051-928 1610 9 a.m. to 8 p.m.

# AMATEUR RADIO CHAS. H. YOUNG LTD. **G3V FV**

170-172 · CORPORATION STREET · BIRMINGHAM B4 6UD

021-236 1635

**MICROWAVE MODULES**

70 MHz Converters 28-287 MHz IF	£16-42
136 MHz " (Satellite Band)	
28-30 MHz IF ...	£16-42
144 MHz " 2-4 MHz IF ...	£16-42
144 MHz " 4-6 MHz IF ...	£16-42
144 MHz " 28-30 MHz IF ...	£16-42
144 MHz " 28-30 MHz IF	
with 116 MHz output	£17-60
432 MHz " 28-30 MHz IF ...	£19-55
432 MHz " 144-146 MHz IF ...	£19-55
1296 MHz " 28-30 MHz IF ...	£25-92
1296 MHz " 144-146 MHz IF ...	£25-92
432 MHz Varactor Triplers ...	£18-90
1296 MHz Varactor Triplers ...	£27-00
144 MHz Preamp (2 outputs) ...	£9-72

Other IF's to order. All above post free

**SOLID STATE MODULES**

144 MHz Converters 4-6 MHz IF (50p)	£16-20
144 MHz Converters 28-30 MHz IF (50p)	£16-20
432 MHz Converters 144-146 MHz IF (50p)	£16-20
144 MHz Preamp in case ... (50p)	£7-36
144 MHz Preamp PA3 for equip. (25p)	£5-94

**MICROPHONES**

Shure 201 ... .. (40p)	£6-60
Shure 444 ... .. (50p)	£16-50

● **Midland Agents**  
for EDDYSTONE, JAY BEAM,  
JOSTY KITS, AMTRON KITS

WE SPECIALISE IN THE SERVICE OF EDDYSTONE RECEIVERS AND CAN ACCEPT MOST MAKES OF COMMERCIALY MADE COMMUNICATION EQUIPMENT.

WE ARE ALSO INTERESTED IN PURCHASING GOOD QUALITY UNMODIFIED SECOND-HAND EQUIPMENT.

**EDDYSTONE**

EC10 Mk. II ... ..	(£2-00)	£165-00
EC10 A2/I Marine ... ..	300-500 kHz	
1.5-30 MHz and 2182 kHz	(£2-00)	£230-00
770U Ex Dem. As New. 140-500 MHz		
(£4-00)		£500-00

Active Aerial LP1506. 10 kHz-30 MHz (75p) £26-40

Headphones LP3301 (padded) 400Ω (75p) £14-25

Headphones LP3242 (600Ω) ... (75p) £12-95

Slide Rule Gearing Dial. Type 898 (75p) £15-79

Diectast boxes various sizes in stock.

**YAESU**

FT101B ... .. (£4-00) £356-40

FR101S ... .. (£4-00) £264-60

**KW**

KW Traps with AT ... .. (50p) £7-56

KW Z Match ... .. (£1-00) £25-92

KW 103 52Ω ... .. (£1-00) £17-28

KW Balun 50/75Ω 1 : 1 ... (30p) £3-24

KW ANT. SW 3-way ... .. (30p) £5-40

Multi-storey Car Park at rear of shop.

**NO C.O.D. PLEASE PRINT YOUR NAME AND ADDRESS. YOU MAY ORDER GOODS BY 'PHONE AND PAY BY ACCESS OR BARCLAY. Enquiries S.A.E. please. Prices include VAT and are subject to change without notice.**

**AERIALS AND AERIAL EQUIPMENT**

Bantex ½ wave 2M Fibre Glass ... (40p)	£3-08
Bantex ¾ wave 2M Fibre Glass ... (50p)	£5-40
Jaybeam	
2M Halo (head only) ... (40p)	£2-00
2M Halo (with mast) ... (40p)	£2-38
5 ele. 2m. beam ... (£1-00)	£4-64
8 ele. 2m. beam ... (£1-00)	£6-05
10 ele. 2m. beam ... (£1-00)	£11-88
14 ele. 2m. beam ... (£1-00)	£18-25
5 ele. 2m. crossed beam (£1-00)	£8-86
8 ele. 2m. crossed beam (£1-00)	£11-02
5 over 5 2m. crossed beam (£1-00)	£8-55
8 over 8 2m. crossed beam (£1-00)	£11-34
4 ele. 4 metre beam ... (£1-50)	£7-34
18 ele. 70 cm. beam ... (£1-00)	£11-77
46 ele. 70 cm. beam ... (£1-00)	£13-07
Low loss 52Ω coax ... per yd. (50p)	46p
Low loss 75Ω coax ... per yd. (50p)	20p
Twin Feed 300Ω ... per yd. (30p)	4p
Twin Feed 300Ω 110 yd. drum (75p)	£3-80
14 SWG H/D Copper Wire 140ft. (50p)	£3-30
Raymarc INS 3" Ribbed ... (10p)	20p
Raymarc AT (centre) INS ... (10p)	20p
SWR 50 SWR/Power ... (50p)	£12-10
FSI Field Strength Meter ... (30p)	£3-48
ML2-200lb. line (approx. 140 yds.) (30p)	£1-50



## CW IS STILL VERY MUCH ALIVE!

### SAMSON ELECTRONIC KEYS

—the choice of Ships and Coast Stations the world over.

Two different models:—

**ETM-2b TRANSISTORISED KEYS**

Developed from the well-established ETM-2. Printed circuit, 11 transistors, 6 diodes. Ratio Control. Single paddle. Speed control, 8-50 wpm. Sidetone oscillator. Almost-inaudible sealed reed relay. Grey case 4" x 2" x 6". Powered by four 2M9 mercury batteries available world-wide. (Price includes batteries.) Well-engineered keying lever, fully adjustable gaps and tensions.

**ETM-2b** — with make-break relay contacts, (Ratings: 1A, 400V., 30W max.) Complete with mercury batteries, £34-16 (or with penlite batteries, £32-73).

**ETM-2bs** — with spdt changeover relay contacts, (Ratings: 0.5A, 250V, 10W max.) Complete with mercury batteries, £38-72 (or with penlite batteries, £37-30).

**ETM-3b INTEGRATED CIRCUIT SQUEEZE-KEYER**

Printed circuit with 4 ICs and 13 semiconductors. Twin paddles. Constant 3:1 ratio. Speed control, 8-50 wpm. Operate/Tune button. AC mains power supply, 110/220-240v. Almost-inaudible sealed reed relay. Grey case 4" x 2" x 6". The renowned SAMSON keying lever movement with fully adjustable gaps and tensions. Can be used either as an iambic mode squeeze-keyer (characters made with fewer paddle movements—you can make a "C" with one squeeze!)—or as a normal electronic keyer.

**ETM-3b** — with make-break relay contacts, (Ratings: 1A, 400v., 30W max.), £37-85.

**ETM-3bs** — with spdt changeover relay contacts, (Ratings: 0.5A, 250v., 10W. max.), £42-36.

### — OR IF YOU LIKE IT STRAIGHT... —

**JUNKER PRECISION HAND KEY**

A superbly engineered straight hand key used for many years by professionals afloat and ashore. With this key you can't help but send good morse.

Free-standing—it does not have to be screwed to the operating desk. Good weight distribution and large rubber feet stop it sliding or rocking. Weight: 2½ lbs. Front and back contacts of precious metal, with fine adjustment of contact gaps by positive click-stop action. Lever-action spring tension adjustment. Spring pigtail at keying arm pivots ensures good contact. Insulated keying arm, moulded knob with rubber anti-slip insert. 3-way terminal block and cable clamp at rear. Key-click filter (L, C & R) built into base. Rear-hinged cover (with spring catch) and other metal parts finished in attractive hammertone grey. Base area: 3¼"W. x 7½"D. Overall height: 2¼", £16-29.

**BAUER KEYING LEVER UNIT**

We have imported this popular unit for many years for inclusion in home-built electronic keys. Adjustable contact gaps and spring tensions. Single paddle on moulded base 1½" x 2". Height: 1" (excluding paddle), so is compact enough to go inside most keys, £5-77.

**BUILDING CW FILTERS ?**

Don't let RTTY and SSTV hog the 88 mH TOROIDS, 41p each.

ALL PRICES INCLUDE VAT

All goods post-paid U.K. Send stamp for Catalogue SP5.

**SPACEMARK LTD.**

**THORNFIELD HOUSE, DELAMER ROAD, ALTRINCHAM, CHESHIRE.**

(Tel. 061-928 8458)



Your South Eastern Stockist

# FAST AND FRIENDLY MAIL ORDER

**BY PHONE** Simply telephone your Barclaycard or Access No. for immediate despatch.  
**BY POST** State clearly your requirements enclosing cheque or postal order.  
**CALLERS** You are always welcome to come and inspect the equipment at our show-rooms.

**FOR ALL ENQUIRIES PLEASE ENCLOSE STAMPED ADDRESSED ENVELOPE.**

## JAYBEAM VHF ANTENNAS

4 element yagi	... £7.34 (£1.00)
5Y/2m yagi 5 element	... £4.64 (75p)
8Y/2m. yagi 8 element	... £6.05 (£1.00)
10Y/2m. yagi 10 element	... £11.88 (£1.00)
PBM14/2m. parabeam	... £18.25 (£1.25)
D5/2m slot fed yagi	... £8.56 (£1.00)
D8/2m. slot fed yagi	... £11.24 (£1.00)
5XY/2m. 5 el. crossed yagi	... £8.86 (£1.00)
8XY/2m. 8 el. crossed yagi	... £11.03 (£1.00)
10XY/2m. 10 el. crossed yagi	... £15.23 (£1.25)
XD/2m. crossed dipole	... £6.21 (75p)
UGF/2m. ground plane	... £4.48 (75p)
HM/2m. Halo with mast	... £2.38 (75p)
D8/70cm. slot fed yagi	... £9.72 (£1.00)
PBM18/70cm. parabeam	... £11.77 (£1.00)
MBM46/70cm. 46 el. yagi	... £13.07 (£1.25)
MBM68/70cm. 68 el. yagi	... £17.39 (£1.50)
12XY/70cm. 12 el. crossed yagi	... £18.04 (£1.00)

Full range of phasing harnesses and Jaybeam brackets in stock. S.A.E. for catalogue.

## MFJ PRODUCTS (U.S.A.)

CVF-2BX boxed cw audio filter	... £13.95 (25p)
SBF-2BX boxed sb audio filter	... £14.58 (25p)
CVF-2 unboxed cw filter	... £9.00 (25p)
CVF-3 unboxed cw filter	... £5.00 (25p)
100BX 100/50/25 kHz boxed calib.	... £11.50 (25p)
MFJ-100 calibrator unboxed	... £9.35 (25p)
MFJ-100 calibrator less xtal	... £11.50 (35p)
CMOS Electronic Keyer with monitor	... £21.06 (25p)

**AT LAST—DX FROM A SMALL GARDEN !!**  
**FABULOUS HQ-1 ANTENNA**

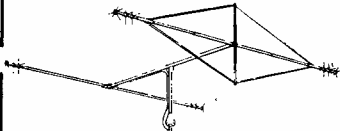

100-15-20m. 1200w. pep  
 Weight 15 lbs. Turning radius 6ft. 2ins.  
 Still only £54, but hurry!

**NEWS FLASH!** G4DML in 1975 CQ contest worked no less than 89 countries in one weekend using FT101 plus HQ-1 mini-beam (ask about a special package deal!) including VK, ZS2, A2, FY0, CRS, TJ, PY, VU, ZL, YV, KP4, VP2, LU, OA, CE0, PJ9, KG4, VP9, etc. This superb piece of American engineering is protected by World patents and now enables the operator with a small garden to compete on the DX bands. Order your HQ-1 now.

## MINI-PRODUCTS "MINI-BEAMS" (U.S.A.)

HQ-1 hybrid quad 10-15-20m.	£54.00 (£1.50)
B242 element yagi 10-15-20m.	£42.12 (£1.50)
RK3 reflector element for B24	£27.00 (£1.50)
C4 vertical dipole 10-15-20m.	£24.30 (£1.30)

## HY-GAIN ANTENNAS

12AVQ 10-20m. self supporting	£20.00 (£1.50)
14AVQ 10-40m. self supporting	£30.00 (£1.50)
18AVT/WB 10-80m. self supporting	... £44.00 (£2.00)

## BELCOM

Liner 2 2m. SSB tcvr. 10w. pep	... £156.00
--------------------------------	-------------

## TRIO

QR666 receiver 160-10m. plus general coverage 230v./12v.	£140.00 (n/c)
Matching 'xtal calibrator	... £9.50 (25p)

## LOWE ELECTRONICS

2m. FM 6 ch. monitor receiver	£19.95 (50p)
'xtals 145/-3/-525/-55/repeaters	£1.50 (5p)

## TONEBURST MODULES

Dual 1700 & 1750 Hz o/p	... £3.95 (15p)
-------------------------	-----------------

## ROTATORS

CDE	... £27.00 (75p)
AR30	... £32.00 (75p)
AR40	... £64.80 (£1.00)
CDE 44	... £33.48 (75p)
STOLLE	... £37.80 (75p)
2010	...
2030	...

## CABLE

5 core round	... yd. 18p (1p)
5 core flat	... yd. 15p (1p)

## ANTENNA FEEDERS

50 ohm UR43	... yd. 18p (1p)
50 ohm RG8U/UR67	... yd. 36p (2p)
75 ohm standard	... yd. 10p (1p)
75 ohm UHF low loss	... yd. 14p (1p)
300 ohm feeder	... yd. 8p (1p)

## COAX FITTINGS

PL259 coax plugs	... 42p (5p)
Reducers	... 15p (1p)
Belling male coax plug	... 12p (1p)
Belling female plug	... 18p (1p)
Belling coax joiner	... 20p (1p)

## MICROWAVE MODULES

NEW! 70cm. transverter 28/70cm.	... £67.00 (50p)
2m. converters 2-4/4-6/28-30	£16.42 (25p)
4m. converter 28-28-7	... £16.42 (25p)
70cm. converters 28-30/144-146	... £19.55 (25p)
2m. pre amp	... £9.72 (25p)
1296 MHz converter 28-30	... £25.92 (25p)
2m. converter 28-30/116 osc.	... £17.60 (25p)

## SOLID STATE MODULES

2m. or 4m. Europa B	... £88.00 (£1.00)
As above less valves	... £74.00 (£1.00)
Matching power supply	... £34.00 (£1.00)
2m. converter 2-4/4-6/28-30	£16.20 (25p)

70cm. converter 144-146	... £16.20 (25p)
2m. pre amp	... £7.36 (25p)
PA3 pre amp	... £5.94 (25p)
70cm. pre amp	... £9.72 (25p)

## TESTED TRADE-INS

FT501 plus psu, 6 months old, mint	... £359.00 (n/c)
Eddystone 830/7, 8 months old, mint	... £395.00 (n/c)
Heath RA1 + calib. + spkr. + Burns FM det.	... £45.00 (cost)
Drake SPR4 receiver brand new	... £279.00 (cost)
Europa 2m. transverter with valves	... £65.00 (£1.00)
Europa 4m. transverter with valves	... £60.00 (£1.00)
Pye base station working on 2m.	... £35.00 (cost)

## SPECIAL SIGNAL PUNCHING PACKAGE

Technical Associates advanced speech compressor with variable compression, decay time and noise gate provides the most economical way of increasing talk power WITHOUT ANY DISTORTION. Still offered at £22.68 (30p) its a bargain with the famous Shure 444 mic at £35 the two units, its unbeatable! Order yours now and save money.

## MICROPHONES

Shure 201	... £6.00 (25p)
Shure 444	... £13.95 (45p)
Yaesu YD844	... £16.12 (30p)

## YAESU EQUIPMENT (ex VAT)

FT101B 160-10m. tcvr. 240v./12v.	... £330.00 (n/c)
FR101D160-2m. rx. 240v./12v.	£330.00 (n/c)
SP101 matching speaker	... £13.00 (£1.00)
FV101 remote vfo	... £48.00 (£1.00)
FT401B	... (n/c)
SP401 matching speaker	... (£1.00)
FT20080-10m. transceiver	... £170.00 (n/c)
FP200 matching spkr./AC supply	... £45.00 (£1.00)
FT220 2m. SSB/FM tcvr. 240v./12v.	... £264.00 (n/c)
FT224 2m. FM tcvr. 24 ch. toneburst	... £130.00 (n/c)
FP2 matching AC/charger supply	... £38.00 (£1.00)
YC355D 200 MHz counter	... £125.00 (n/c)
YO10M monitor scope (superb!)	... £93.00 (£1.00)

## SWAN EQUIPMENT (ex. VAT)

700cx transceiver plus psu	... £395.00 (n/c)
700cx/ss16 transceiver plus psu	... £435.00 (n/c)
Remote vfo unit	... £99.00 (n/c)
Vox unit	... £25.00 (n/c)

# WATERS & STANTON ELECTRONICS

HOCKLEY AUDIO . SPA ROAD . HOCKLEY . ESSEX

Prices include VAT (unless stated)

Early Closing Wednesday

HP—Trade-ins.

Telephone : 03-704 6835

# TELFORD COMMUNICATIONS

### TC 10

Mains or D.C. operated 2 Metre Tx with A1/A3H/A3/F3 modes, full high stability Mixer VFO coverage plus one Xtal controlled A3J calling channel. 10 Watts RMS 25 Watts PEP output. Repeater Tone access. Integral solid state aerial C/O and Control/Muting Relays. Fully stabilised and protected PSU. **£140.40.**

### TC 5

12 Volt negative earth 2 Metre Tx, 2 Watts output with up to 5 channels Xtal controlled A3, or with companion TC 6 A3/F3. Ideal for Mobile use, supplied with Ch 1 Xtal on 145.5 MHz complete with Ae C/O relay, Converter muting and Microphone. **£38.60.**

### ANCILLARY EQUIPMENT

**2 Metre Bandpass Aerial Filter**  
Ideal to clean up those unwanted Tx sprogs or to remove the Rx Broadcast/TV sprogs. Rejection at ± 10 MHz not less than 22dB. 10 Watt power handling capacity. **£6.48.**

### TC 7 Bandsearcher

Enables automatic electronic scanning of the band to be selected with a TC 7 Tunable IF, by application of a decaying bias to the varicaps. Scans and Resets approx. once per minute. **£5.40.**

### Solid State Ae C/O Relay

10 Watts capability up to 23 cms. Insertion loss 0.8dB. Isolation 28dB at 23 cms. 12 Volt Negative Earth required. **£5.40.**

### Solid State Ae C/O Device

As used in the above, will handle 150 Watts CW with appropriate heat sinking up to 10 GHz. Complete with circuit and gen. **£3-24.**



Photo by Cris Cooper

**G8AEV MK. 2 2 METRE CONVERTER**  
The well-known kit in ready-built form with 3 IF outputs for contest use etc. All popular IF's available. 12 Volt D.C. operated either polarity earthed. Typical gain 20dB, typical N.F. 3dB. Join the other 650 users for **£14.40.**

### TC 7

Tunable I.F. unit A1/A3J/A3/F3. Any 2 MHz coverage between 20 and 30 MHz. (Standard Model 28-30.) Mains or DC operation. Varicap tuned front end. 4in. Scale length individually calibrated at 100 KHz increments. 5 Meter (c. zero on F3) integral monitor loudspeaker. I.F. output at 1.6 MHz for 'scope etc. Can't be beat at the price, over 250 now sold. **£54.00.**

### TC 9

Mains or DC operated 2 Metre Tx with A3/F3 modes, full high stability Mixer VFO coverage plus one Xtal controlled channel to choice. 10 Watts output. Integral solid state aerial C/O and Control/Muting Relays. Fully stabilised PSU. **£91.80.**

Repeater Access outboard Unit available for an extra **£10.80.**

### TC 6

Companion Unit to TC 5 providing full high stability coverage of the 2 Metre band with A3 or F3 mode.

Also available with 45 MHz output for the DIY S.S.B. enthusiast. **£32.40.**

### GENERAL

All prices VAT inclusive. Securicor delivery of TC 10/9/7 please add **£4.86.**

H.P. available, otherwise C.W.O. or small deposit with balance pro-forma invoice on longer delivery terms.

**London Agent—Reg Vincent, Hoddeson 64285 EVENINGS only.**

Large SAE please for further details and delivery schedules.

## FOR ALL YOUR 2 METRE SOLID STATE BRITISH-BUILT EQUIPMENT

**78B HIGH STREET, BRIDGNORTH, WV16 4DS, SALOP. Telephone 074-62 4082 9 a.m. - 5.30 p.m.**

# MSI MARKETING SERVICES INTERNATIONAL

(A COOKE INTERNATIONAL ELECTRONICS COMPANY)

PLEASE ADD 8% VAT TO ALL UK ORDERS

### RADIO TELEPHONES

GEC Desk top base station RC 700 H/B F/M single channel. Nearly new 12½ Kc/s. bandwidth, **£90.00.** Can be installed and crystallised by our engineers.  
**STORNO QCM13C**—a few only left—boot mount, H/B F/M main set valued. Transistor inverter. Single channel, but not difficult to convert to six. Supplied less control box, but otherwise complete, with copy of manual. **£9.00.** Prefer buyers collect and select their own choice.  
 Pair of ex-WD sets, complete in webbing harness, with Xtals. The pair, **£15.00.**  
 Shure Desk mikes Type 444T (contain transistor pre-amp). New but not boxed, **£16.00.** p. & p. 50p.  
 Also agents for Murphy Marine and Land Based Radio Telephones. S.A.E. for literature.

### QUARTZ CRYSTAL DEVICES

NEW Xtal. filters for 10.7 MHz IF, 25 Kc/s. channel spacing. Details on application. S.A.E. please.  
 NEW ex-stock crystals as follows:  
 100 Kc/s. HC 13U 20 ppm 30pf parallel res., **£3.00** ea. inc. p. & p.  
 1 MHz HC 6U 20 ppm 30pf parallel res., **£3.00** ea. inc. p. & p.  
 10-230, 10-245, 10-7 and 10-8 MHz IF crystals HC/18-U all at **£2.50** ea. inc. p. & p.  
 48-0125 MHz HC 25U 20 ppm 30pf parallel res., **£2.00** ea. inc. p. & p.  
 460 Kc/s. Double crystals = 2 crystals in glass envelope B7G base. Separation 450-550 Hz dependent on circuit. Inductance 30 Henries. Suitable or lattice filter at 460 Kc/s. See R5GB Handbook for circuit, **£2.00** ea. inc. p. & p.  
 Other frequencies to order—approx. 4 weeks delivery. **£4.00** ea. inc. p. & p.  
 5-20 MHz 30 ppm 30pf par res. ... .. **£4.25** ea. inc. p. & p.  
 21-50 MHz 30 ppm 30 pf par res. ... .. **£4.25** ea. inc. p. & p.  
 51-65 MHz 30 pf par res. ... .. **£4.65** ea. inc. p. & p.  
 Other types and specifications can be made to order. S.A.E. please. Quantity discounts available for 5 and over.

### CONDUCTORS' EQUIPMENT

The following components are ex-stock:  
 The following are new components in bags, suitable for most popular transistor radio projects:  
 Fixed capacitors, with or without useful selection **55p** per bag, inc. p. & p.  
 Tuning capacitors, miniature, 4 in bag **55p** " " " "  
 Knobs, black, small, silver insert, 6 in bag **50p** " " " "  
 Ditto medium, and pointer, 6 in bag **55p** " " " "  
 Audio output transients, 10 in bag, various **55p** " " " "  
 Ferrite rods and slabs, assorted, some long **50p** " " " "

### ODDS

Ex-computer panels containing Transistors, Diodes R's and C's and some having IC's and trim pots as well, 5 boards, **£1.50**, inc. p. & p. 45 ohm 5in. loudspeakers, new in makers' boxes, **45p**, inc.  
 New motors 1/20th HP continuously rated as follows, 110v. DC, **£1.50**, carriage UK **£1.00**. 115v. AV ditto. 220v. DC, **£2.00** plus carriage, 240v. AC, **£3.00** plus carriage. Fully shrouded four-hole flange fixing. Capacitor start.  
**PLASTIC TOOL PACKS** with felt insert to prevent rusting, complete with fixing screws for wall or bench. New in boxes, **25p**, inc. p. & p.  
 Miniature mains cable, grey, PVC covered 3-core 15p metre. Hook up wire 7-0076 PVC covered 10p metre. Single strand 5p  
 Ferrite rod ¼ in. x 8 in., **20p**, inc. p. & p.  
 Crystals ovens, 6 or 12v. AC or DC. Double holder odd base, **50p**, inc. p. & p.

### TEST EQUIPMENT

Solartron regulated power supply, type SR515A 0-500v. max., **£25.00.**  
 Marconi circuit magnification meter TF 886A. Will measure inductance, and capacitance up to 180 MHz, **£30.00.**  
 Cintel wide range capacitance meter type 1863. Reads capacitance .3pf-1000pf. Resistance 1 ohm-300 Mohm, **£35.00.**  
 Marconi valve voltmeter FT 428 B/2 max. 150v. volt., **£10.00.**  
 Dawe valve voltmeters choice of two type 613B, **£5.00.**  
 Other test equipment available from time to time S.A.E. with your enquiries please.  
 Carriage charges are not shown on Test equipment since we prefer you to collect, but delivery can be arranged, at cost.  
**TERMS:** Cash on delivery. Trade accounts welcomed. Two Trade references and bank please.  
**MINIMUM ORDER CHARGE £1.00**, carriage extra, unless otherwise stated. All prices exclude VAT which must be added to UK orders.

### ALL CORRESPONDENCE TO

**RAMALLA HOUSE, ANCTON LANE, MIDDLETON-ON-SEA, BOGNOR REGIS, SUSSEX, PO22 6NJ Telephone 024-369 2849**







## Mustang Mk2

Specifications  
 Span 26' 11/2"  
 Length 12' 0"  
 Weight 26 lbs  
 Power Unit : Any Exciter  
 up to 2KW SSB  
 Armament : High Power Traps  
 Price £60+carriage & VAT

# two of a kind

## SOME ANTENNAS

**ATLAS**  
 Trap Vertical, 10, 15, 20 and 40 metres  
**£26.00**  
**Tri-band**  
 TA 33jr 3el 10, 15, 20m.  
**£45.00**

## Mustang P51 D

Specifications  
 Span 37' Length 32' 3"  
 Weight 10,000 lbs  
 Power Unit: Rolls Royce  
 Armament : 5 Browning MG  
 Price \$51,000 (out of production)

Our antennas are built around Stainless Steel hardware and heat treated alloy tubing for highest quality and value.

# MOSLEY

## Electronics Ltd

Send for **HANDBOOK** containing full details of Antennas and other technical information. 33 pages 25p. Refundable upon purchase of Antenna.

Administrative Address only  
 40 Valley Road, New Costessey, Norwich, Norfolk, NR5 0BD

# THE ROARING FLEA!!

A "flea powered" VFA from an average location, operated mainly in the "rush hours" regularly penetrates the "jungle" on the 80, 40 and 20 metre bands. How is this possible with a 230 cm. antenna? By combining **LOW ANGLE** with a virtual **ABSENCE** of **POWER WASTING HARMONICS**.

ANY antenna can do it with high power — **WE'RE TALKING ABOUT FLEA POWER!**

**PARTRIDGE** have a complete **VFA SYSTEM**, correctly terminated for your equipment ranging from modern communications gear to a modest solid state radio. Don't be satisfied with anything less than the **PARTRIDGE WORLD RECORD ANTENNA SYSTEM!** Make your selection from the list below:—

(Each **SYSTEM** consists of the elegant gold stove enamelled 7' 6" VFA and a matching finish **JOYMATCH A.T.U.**, despatched direct by parcel post—our risk). (All prices delivered—our risk). Prices subject to alteration without notice.

<b>SYSTEM 'A'</b> for modern Communications Receivers ... ..	<b>£28.61</b>
<b>SYSTEM 'D'</b> for other S.W. and M.W. receivers, all types ... ..	<b>£21.02</b>
<b>SYSTEM 'J'</b> for TXs and TCVRs up to 500w PEP 160 thru 10m (pa inpt) ... ..	<b>£33.78</b>
<b>JOYMATCH A.T.U.</b> kit (1.6 continuous to 30 MHz) ... ..	<b>£6.40</b>
<b>JOYMATCH A.T.U.</b> kit (500 kHz continuous to 30 MHz) ... ..	<b>£6.40</b>
Either kit fully assembled ... ..	<b>£7.71</b>
<b>JOYMATCH "Aerial Bandswitch"</b> tuned aerial. MW & SW ... ..	<b>£6.40</b>
<b>SUPER SENSITIVE</b> general coverage DX-CRYSTAL SET that <b>REALLY WORKS</b> , not a toy, complete with Aerial and a sensitive matching Earpiece ... ..	<b>£4.08</b>
<b>COMMUNICATIONS HEADPHONES</b> , 8 ohms, matches most modern Comm. Rxs. ... ..	<b>£4.15</b>
<b>VFA Stack Lashing</b> (Massive VFA support on chimney stack) ... ..	<b>£2.54</b>
<b>JOYMATCH Artificial Earth</b> (ground) switch tuned ... ..	<b>£6.40</b>
<b>A.G.T.U.</b> Artificial Earth D.I.Y. add on unit for your A.T.U. ... ..	<b>63p</b>
Radials for the A.G.T.U. cut to required band ... ..	<b>63p</b>
<b>"INVISIBLE AERIAL"</b> wire, tough PVC covered tinned copper 22swg per 10m. ... ..	<b>63p</b>
<b>A.G.T.U.</b> supplied fitted to <b>JOYMATCH A.T.U.'s</b> (less radials)... ..	<b>83p</b>
<b>AERIAL WIRE</b> , heavy duty 16swg enamelled aluminium, per 10 metres ... ..	<b>63p</b>
<b>VALVES</b> , complete set for 9R59DS and 9R59DE, including OAS stabiliser ... ..	<b>£5.28</b>

## PARTRIDGE SUPER PACKAGE

**COMPLETE RADIO STATION FOR ANY LOCATION**  
 Comprising:—Trio QR666 Gen. Cov. RX, Headphones, V.F.A. System 'A'; all connecting cables, delivery (our risk).

**£157.58**

SEND STAMP FOR DETAILS

BOX 4 **PARTRIDGE**  
 BROADSTAIRS KENT ENGLAND  
**ELECTRONIC LTD**

Phone 0843 62535  
 or 62839  
 (after office hours)  
**G3CED G3VFA**



# J. BIRKETT *Radio Component Suppliers*

## 25 THE STRAIT . LINCOLN . LN2 1JF

Telephone: 20767

- VHF-UHF FET's type BF 256A 800 MHz at 25p each. 5 for £1.10.  
**BB121A TUNING VARACTORS**, 15p each.  
**DUAL GATE MOS FET's** 40601 at 50p, 40603 at 50p, 40673 at 55p, MEM 616 (40673) at 50p.  
**2N 3375 VHF 7 Watt R.F. TRANSISTORS** at £2.16 each.  
**MOS P CHANNEL FET's**. 20 for 50p with circuits.  
**PLASTIC NPN-PNP MIXED TRANSISTORS**. 85% good. 50 for 10p.  
**76550 (TAA550) VOLTAGE STABILISER I.C.** For Vari-Cap Tuners at 10p each.  
**25 PLASTIC BC 107 NPN TRANSISTORS**. 85% good at 50p.  
**.01uf, 02uf 50v.w. DISC CERAMICS**, 15p doz.  
**MATCHED QUAD DIODES** like CV 2279, 50p the four.  
**MULLARD C280**. .1uf 400v.w. at 20p doz., .47uf 400v.w. at 6 for 15p.  
**BY 103 1300 PIV 1 Amp SILICON DIODES** at 15p each.  
**METAL TO 18 TRANSISTORS**. Similar to BC107/8/9. Untested extremely good buy, 25 for 50p.  
**SUB-MINIATURE CERAMIC TRIMMERS**. 4.7 to 20pf at 3 for 10p.  
**75 MULLARD C280 CAPACITORS**. Assorted at 80p.  
**WIRE ENDED 1000uf 30v.w. CONDENSERS** at 15p each.  
**LARGE PACKET OF MICA WASHERS**. For semi-conductors T03, BD131, bushes, etc. at 30p.  
**BF 271 1 GHz RF TRANSISTORS** at 15p each.  
**TEXAS THYRISTORS TIC 45**. 60 PIV 600mA at 15p each.  
**20 BRANDED AC 128 TRANSISTORS** at 50p.  
**D.C. MOVING IRON CHARGER TYPE METERS**. 0-2, 0-3, 0-5 Amps. All at 60p each.  
**UHF STRIP LINE 2 GHz TRANSISTORS** like BFR90 at £3.  
**SANYO 15 Watt AUDIO MODULE** with data at £3.  
**5 ASSORTED UNMARKED GOOD TRIACS**. For 80p.  
**IN 4007 1000 PIV 1 Amp SILICON DIODES**. 16 for £1.08.  
**COMPRESSION TRIMMERS**. 10pf, 30pf, 50pf, 1000pf. All at 5p each.  
**SUB-MINIATURE ROTARY SWITCHES**. Small spindle, 2 pole, 5-way, 2-bank at 22p; 1 pole 6-way at 15p.  
**1000pf 500v.w. TUBULAR CERAMICS**, 15p doz.  
**GOLD BONDED DIODES**, £3 per 1000.  
**STC 1 Watt ZENERS**. 3-3, 3-6, 4-3, 13, 16, 18, 20, 24, 30 volt. All at 15p each. 3 for 35p.  
**365pf 3 Gang TUNING CAPACITORS**. Size: 2½ x 1½ x 1½ at 66p.  
**1 Watt AUDIO I.C.** type TAA 611B with data at 65p each.  
**BRANDED TRANSISTORS** BC 107, BC 308, BC 177, 2N 706, 2N 706A, BSY 95A, BC 213L, BC 214L, Lockfit types BC 147, BC 148, BC 149, BF 194, BF 195, BF 196, BF 197. All at 6 for 50p.  
**50 ASSORTED MULLARD CAPACITORS**. Consisting of 10x.01uf, 1x.015uf, 2x.022uf, 2x.033uf, 2x.047uf, 10x.1uf, 1x1uf, 10x.22uf, 2x.33uf, 8x.47uf, 2x.68uf. The 50 for 80p.  
**UNMARKED BC 109 TRANSISTORS**, 10p each. 6 for 50p.  
**THYRISTORS**. 100 PIV 10 amp at 25p. 400 PIV 10 amp at 50p. 800 PIV 10 amp at 60p.  
**SUB-MINIATURE TOGGLE SWITCHES**. SPCO at 35p. DPDT at 44p.  
**DC MOVING IRON CHARGER TYPE METERS**. 0-2, 0-3, 0-5 amp. All at 60p each.  
**TRIPLE 300 MHz NPN TRANSISTORS**. In Ten Lead TO 5 Can Untested with data at 5 for 44p.  
**6 PLASTIC NPN POWER TRANSISTORS**. Untested for 50p.  
**TRANSISTORS SIMILAR TO 2N 2926G**. 10p each. 5 for 40p.  
**X BAND GUNN DIODES** with data at £1.65.  
**X BAND DETECTOR DIODES**. Similar to SIM 2 at 15p, IN 23 at 25p.  
**X BAND PIN DIODE**. Type MA 4571-A1 at 50p each.  
**UNMARKED 10 WATT ZENERS**. 12, 13, 15, 16, 18, 20 volts. All at 22p each.  
**MOTOROLA TUNING VARACTORS**. Type MV 1636 200 MHz, 24 to 30pf at 30p each.  
**UNMARKED VHF-UHF SIGNAL NPN TRANSISTORS**. 40p doz.  
**2000uf 30v.w. CONDENSER**. Size: 2½ x 1" at 15p each.  
**LOCKFIT TRANSISTOR**. Untested PNP, 16p doz. NPN, 16p doz.  
**400 PIV 10 amp SILICON BRIDGES** at 83p each.  
**SOLDER-IN FEED THRO's**. 1pf, 2pf, 10pf, 15pf, 18pf, 22pf, 300pf. All at 15p doz.  
**50 PLASTIC NPN TRANSISTORS**. 85% good at 50p.  
**50 PLASTIC NPN TRANSISTORS**. 85% good at 50p.  
**TO 18 SILICON PHOTO TRANSISTORS** at 44p each.  
**GRADED TO 18 PNP SILICON TRANSISTORS**. For general purpose use in gain groups of up to 80, 5 for 12p; 80 to 200, 5 for 20p; 200 to 400, 5 for 25p; 400 up, 5 for 30p.  
**50 AC 128 TRANSISTORS**. Untested at 50p.  
**12 AF 117- OC 170 TRANSISTORS**. Unmarked at 33p.  
**500+500+20+20pf TUNING CONDENSER** at 33p each.  
**JAPAN TRANSISTOR KIT** consisting of 3x2SA49, 3x2SA52, 3x2SA53, 3x2SB56. The 12 for 42p.  
**TEXAS HIGH SPEED DIODES**. Type IN 3881R, 400 PIV, 6 amp at 20p.  
**MULLARD OP-AMPS TAA 243** at 30p each.  
**GENERAL PURPOSE HIGH GAIN PLASTIC NPN TRANSISTORS**, 40p doz.  
**ZN414 RADIO I.C.** with data at £1.20.  
**GERMANIUM DIODES**. IN 34A, OA 85, OA 91, OA 95. All 8p each.  
**AF 279 PNP STRIPLINE 800 MHz TRANSISTOR** at 44p.  
**COLOUR T.V. CONVERGENCE POTS**. 10 ohm, 50 ohm, 75 ohm. All at 10p each.  
**COLOUR DELAY LINE**. Mullard type at 40p.  
**MULLARD 10 Watt AUDIO AMPS**. Type LP 1173 at £2.16.  
**25 PLASTIC BC 107 type TRANSISTORS**. 85% good, 40p.  
**TEXAS BRIDGES 100 PIV 1 Amp**. type 1B1OJ10 at 22p each.  
**PRECISION ZENERS**. 250mW 6.6 volt, 9.8 volt, 11.4 volt. All at 15p each.  
**TANTALUM BEAD CONDENSERS**. .15uf 35v.w., 1uf 35v.w., 2uf 25v.w., 2.2uf 35v.w., 4.7uf 35v.w., 5uf 25v.w., 6.8uf 25v.w., 6.8uf 35v.w., 10uf 16v.w., 15uf 10v.w., 20uf 6v.w., 22uf 16v.w. All at 8p each.  
**10-7 MHz CERAMIC FILTERS** with data at 27p.  
**PHOTO TRANSISTOR PACK**. 4 Germanium types, 4 Silicon types, £2.16.  
**MULLARD TAA 242 OP-AMP** at 30p.  
**50 IN 4000 Series**. Untested Silicon Diodes at 50p.  
**10 SILICON 10 Amp STUD DIODES**. Untested at 25p. 50 for £1.  
**10 SILICON 20 amp STUD DIODES**. Untested at 50p.  
**VHF TUNING VARACTORS**. Untested, 6 for 25p. 30 for £1.  
**100 Untested 400mW ZENERS**. Untested at 50p.  
**100 Untested 2 watt ZENERS**. Untested at 50p.  
**50 MINIATURE TRANSISTOR ELECTROLYTICS** at 50p.  
**20 P CHANNEL MOS FET's** with data. For 60p.  
**BF224 LOW NOISE R.F. NPN TRANSISTOR**. FT 600 MHz. 6 for 50p.  
**OXLEY MINIATURE 30pf AIRSPACED TRIMMERS** at 5p each.  
**MULLARD SUB-MINIATURE 60pf AIRSPACED TRIMMERS** at 8p each.  
**DISC CERAMICS**. .1uf 3v.w. at 10p doz., .1uf 30v.w., 15p doz.  
**BLACK and SILVER INSTRUMENT KNOBS**. 1" dia. at 18p; 2" dia. 25p.  
**TEXAS R.F. AMPLIFIER TRANSISTORS**. GMO 378 at 35p each.  
**200 ASSORTED TUBULAR CERAMICS** at 50p.  

Member of the ARRA  
Please add 10p post for orders under £1.

# NEW! UNIVERSAL R.F. SPEECH CLIPPER

INCREASES 'TALK POWER' — ELIMINATES 'FLAT TOPPING'

Easy to install — long battery life

- ★ Simply connect in series with your microphone lead. Needs no internal connection to your transmitter. Push-to-talk facilities are retained.
- ★ Can give increased "punch" or "talk power" comparable to a times-ten power increase, plus improved speech characteristics
- ★ Ideal for SSB, AM, or FM.
- ★ Advanced circuit uses optimised combination of digital and analogue techniques for long-term reliability and stability.
- ★ Seven integrated circuits, one transistor, three diodes.

**DESCRIPTION :** The Datong R.F. Clipper brings the unique benefits of rf clipping to any conventional transmitter. It should not be confused with agc-type speech compressors or af clippers. The Datong R.F. Clipper is a complete closed-circuit ssb transmitter and receiver. Amplitude clipping of the internally generated ssb signal (at 60 kHz) greatly increases the average-to-peak amplitude ratio of the speech input signal. This is achieved without harmonic distortion.

Price, including delivery by parcel post, only £45 plus VAT. Add 43p for delivery by registered first class mail.

Write or phone for full information, including a copy of the installation and operating instructions.

£45 + VAT

See August Rad. Comm. for a review of this equipment

#### JAPANESE MICROPHONE SOCKETS

The Datong Clipper is now also available fitted with a Japanese 4 pin screw-locking type of input connector in place of the normal stereo jack. This allows, for example, FT101 or TS700 microphones to plug straight in. Since connection details vary, please specify the actual connections required when placing your order. Price: £47 plus VAT, or, if ordered complete with output lead fitted with matching connector (i.e. lead type R.FC/JAP4pin), £48.50 plus VAT for the pair. Add 40p plus VAT for registered first-class delivery.

## DATONG ELECTRONICS LTD.

11 MOOR PARK AVENUE ● LEEDS LS6 4BT  
Telephone : 0532-755579

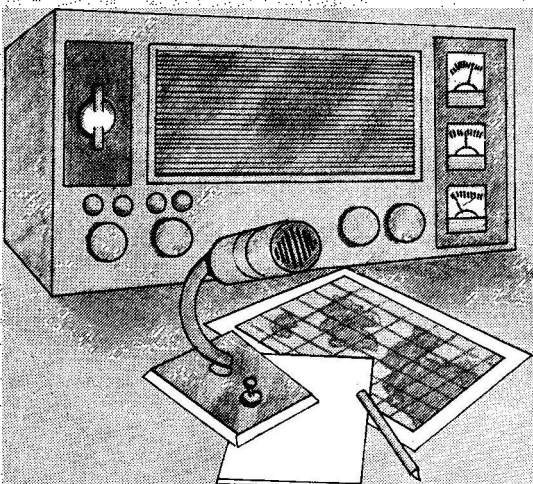

# Become a radio amateur.

Learn how to become a radio-amateur in contact with the whole world. We give skilled preparation for the G.P.O. licence.

WAA

Brochure, without obligation to:

BRITISH NATIONAL RADIO & ELECTRONICS SCHOOL, Dept SWB 475

P.O.Box 156, Jersey, Channel Islands.

NAME \_\_\_\_\_

ADDRESS \_\_\_\_\_

(Block caps please)

Free!

# SOLID STATE MODULES

Telephone: 0484 - 23991

**63 WOODHEAD ROAD,  
SOLID, LOOKWOOD,  
HUDDERSFIELD, HD4 6ER.**

OUR OWN TESTS CARRIED OUT ON LABORATORY TEST EQUIPMENT, AND INDEPENDENT TESTS, HAVE SHOWN THAT THESE UNITS PROVIDE THE HIGHEST PERFORMANCE YOU CAN BUY ON THE AMATEUR MARKET.

### CONVERTERS

2 metres, 4 metres, 70cm, Satellite Band (136-138 MHz), Marine Band from stock. Other frequencies to order.

### SENTINEL DUAL GATE MOSFET 2 METRE OR 4 METRE CONVERTERS

- \* N.F. 2 dB. Gain 30 dB.
- \* Dual gate MOSFETS in RF and MIXER stages.
- \* No oscillator frequency multiplication.
- \* 2 metre IF's: 28-30 MHz, 2-4 MHz, 4-6 MHz.
- \* 4 metre IF: 28-28.7 MHz.
- \* Size: 2½" x 3" x 1½" except 2-4 MHz and 4-6 MHz being double conversion are 4" long.
- \* Price only £16-20. Ex. Stock.

### SENTINEL X DUAL GATE MOSFET 2 METRE CONVERTER

A de luxe version of our Sentinel converter, containing a mains power supply or external battery operation. It has front panel R.F. gain control. Technical data is the same as the Sentinel. Size: 5" x 1½" front panel, 4" deep. Stock IF's: 2-4 MHz, 4-6 MHz, 28-30 MHz. Price: £21-06. Ex stock.

### THE SENTINEL 2 METRE CONVERTER KIT, 28-30 MHz Ex stock

The kit is supplied with printed circuit board drilled and all coils mounted to make assembly so simple. All components, metalwork, nuts and bolts etc. are supplied. Performance data is the same as our Sentinel converters. Price £11-00. IF it doesn't work, send it back with £2 and we will fix it for you.

### THE SENTINEL MF DUAL GATE MOSFET 2 METRE TO MEDIUM WAVE CONVERTER

Receives 2 metres on a conventional MW BC receiver, very good used with a car radio. I.F. output of 0.5 MHz-1.5 MHz for 144-5 and 145-6 MHz in two switched bands. Size: 5" x 1½" front panel, 4" deep. Price: £20-25.

### SM 70 FET CONVERTER

- \* IF output 144-146 MHz. Noise figure 3-5 dB. Gain 30 dB.
- \* Size: 2½" x 3" x 1½".
- \* By using the SM70 with your 2 metre receiver you get excellent 70 cms. receiving performance for only £16-20. Ex stock.

### EUROPA 70 CM FET RECEIVER CONVERTER

- Can be used as a receive converter on its own or in conjunction with our Europa transmit converter for transmit operation as well.
- \* U.F. output 28-30 MHz. Noise figure 3-5 dB. Gain 30 dB.
- \* Two FET RF amplifiers and FET mixer.
- \* Oscillator chain uses a 101 MHz crystal with oscillator output socket to drive the Europa 70 transmit converter.
- \* Size: 2½" x 4" x 1½".
- \* Price of this extremely high performance unit, £20-52.

### PRE-AMPLIFIERS

2 metres, 10 metres (Oscar), 70 cms, Satellite (136-138 MHz) from stock. Other frequencies to order.

### SENTINEL LOW NOISE FET PRE-AMPLIFIER Ex stock

- If you want the ultimate in 2 metre sensitivity and selectivity:
- \* Built in a box which matches our converters.
- \* Isolated supply lines make it compatible with any existing polarity.
- \* Low noise figure—1 dB. Gain 18 dB.
- \* High selectivity tuned circuits.
- \* Price: £7-36.

### THE PA3 DUAL GATE MOSFET PRE-AMPLIFIER Ex stock

- \* Small (about one cubic inch) printed circuit board pre-amplifier developed to fit inside transceivers where it can be wired into the receiver aerial lead after the c/o relay.
- \* Low noise figure—2 dB. Gain—18 dB. Price: £5-94. Supplied with fitting data.

### SM 71 70CM PRE-AMPLIFIER Ex stock

- A selected 2 stage FET pre-amplifier.
- \* Noise figure 3-5 dB. Gain 18 dB.
- \* Size: 2½" x 4" x 1½". Price: £9-72.

See our advert on page 72

# TELECOMMUNICATIONS INTERNATIONAL AGENCY LTD.

**NEW RADIO TELEPHONES.** FM or AM. High, low and Marine bands. Catalogue on request.

**LINER 2.** Add on amplifier module comprising of 40 watts PEP amplifier and preamp for the RX. Extremely simple to use with any liner 2, but could be easily adapted for use with any TX RX requiring more power and better sensitivity.

- With RX preamp ... .. £47-42, carriage £1-00
- Without RX preamp ... .. £40-10, carriage £1-00

### VALVES

Various New and Second-hand. Price on application. Discounts on quantity.

- Heathkit HD-1234. Aerial Switch. New £6-00, carriage 15p
- MR 960 Units LB. Bootmount used condition. No remote units. Can be converted to 12.5 kc/s ... £5-00, carriage 78p
- New Power Unit for Transmitter ... Complete £30-00
- Steel cases, blue, for the above Units ... £20-00
- New 50 Watt AM Transmitter Chassis less valves and coils £30-00
- N.B. The above Unit can be used on 12.5 kc/s.

Carriage charges, Securicor, £6-50

- 5 pin type B din plugs ... 14p
- 5 pin type B din sockets 8p
- Painton 6-way plugs ... 12p
- Toggle Switches. 10 amp-25v. (centre off position) 15p + 5p p. & p.
- MC MURDO RED RANGE**
- 24-way plugs ... 40p
- 12v. 2:2 lamps MCC 643 10 for 10p
- 32-way sockets ... 50p
- 32-way plugs ... 50p
- 6-5v. 3 amps lamps MCC 10 for 10p
- F. & E. plugs ... 45p
- 2 N2569a ... 15p

Various other transistors. List on application

### TRANSISTORS

- PT 4176D 44w. ... £3-00
- PT 4176B 10w. ... 67p
- PT 4176C 20w. ... £2-23
- PY 4176A 3w. ... 45p
- 2N 4427 5w. ... 67p

**ULTRA FM AND AM BASE STATION.** 12½ kHz type approved in extremely good condition. In working order, complete with desk controller 7-9 watts £66-00, carriage £1-00

**XTAL OVENS.** Cathodeon reduced price 48p, carriage 5p

**RELAYS.** Mains contact heavy duty 12v. coil 75p, carriage 10p

**PAIGNTON.** 4-way Chassis mounting sockets and 6-way free sockets ... 12p each + 5p p. & p.

**MOBILE Car Aerials,** complete on 144 megs. Fibre glass whip £1-50 each, 20p p. & p.

**NEW MURPHY PSU** stabilised 12.5v. DC at 10 amps. £29-95, carriage 45p

24v.-12v. converters ... £14-95, carriage 50p

**SCHOMANDL** frequency counter. Slight attention needed £75-00, carriage extra

**HAND SETS.** New SG Brown handsets £5-00, carriage 23p

**HAND PORTABLES.** Corsor type CC2/8 Mk. 2. V.H.F. Walkie Talkies. High Band FM ... £60-00 + carriage

**SGB CLASSIC.** Ultra modern mobile microphone dynamic £7-00, carriage 20p

**S.G. BROWN MICROPHONE** storage units. New, 45p carriage 5p

**S.G. BROWN** fist microphone. Dynamic 300 ohms £4-50, carriage 10p

**S.G. BROWN DIPLOMAT** 300 ohm headset and 300 ohm microphone ... £7-50, carriage 20p

**S.G. BROWN DIPLOMAT** headset 22 ohms with 22 ohms microphone complete with din plug £5-50 each, carriage 20p

**S.G.B. PACIFIC** 4c400/5 3k ohms mic + 150 ohm RX £7-50, carriage 20p

**S.G.B. DIPLOMAT HEADSET** 68 ohm mic + 50K ohm RX £7-50, carriage 20p

**S.G.B. HEADSET ONLY** 250 ohm + 250 ohm series 75p, carriage 20p

**S.G.B. HEADSET ONLY** 22 ohm + 22 ohm 75p, carriage 20p

**S.G.B. HEADSET ONLY** 50k ohms... 75p, carriage 20p

**S.G.B. HEADSET B94** 600 ohms total ... 50p, carriage 20p

S/H Fist and Handset microphone complete with leads. Ex R/T equipment ... 50p each, 10p p. & p.

ALL PRICES EXCLUDE VAT

SUBJECT TO EQUIPMENT BEING UNSOLD

**BROCKENHURST STUDIOS, FIBBARDS ROAD, BROCKENHURST HANTS.**

Tel.: Brockenhurst 2219, 3430 or 3434

# R. T. & I. ELECTRONICS LTD.

where equipment is fully overhauled

HEATHKIT GR64 Receiver	£25.00 (£2.00)
HEATHKIT SB300 Receiver	£95.00 (£3.00)
HEATHKIT DX100 Transmitter	£50.00 (£5.00)
HAMMARLUND SP-400-JX Receiver	£160.00 (£3.50)
HAMMARLUND HQ-170 Receiver	£120.00 (£3.50)
KW-201 Receiver	£100.00 (£5.50)
KW-2000A with A.C. P.S.U.	£180.00 (£4.00)
KW-204 Transmitter	£180.00 (£4.00)
KW VESPA Mk. II, with A.C. P.S.U.	£105.00 (£4.00)
EDDYSTONE EA12 Receiver	£160.00 (£3.50)
STAR SR-550 Receiver	£50.00 (£2.00)
EDDYSTONE 730 Receiver	£95.00 (£3.00)
HEATHKIT SW-717 Receiver	£30.00 (£2.00)
R.216 Receiver, V.H.F. Receiver	£105.00 (£3.50)

WE CAN ALSO SUPPLY ANY MAKE OF NEW EQUIPMENT—and have pleasure in giving a few examples which are normally in stock:—

**AVOMETERS.** Model 7, Mk. 2, £48.82; Model 8, Mk. 5, £52.24; Model 40, Mk. 2, £48.82; Model 72, £20.06; Multiminor Mk. 4, £17.35; Standard Leather Carrying Case (Models 7, 8, 40), £9.80; Ever Ready ditto, £11.35; Multiminor Leather Case, £5.05; 10KV D.C. Multiplier for Model 8 or 9, £9.00; 30KV D.C. ditto, £13.00; Pair of Long Reach Safety Slips, £1.93; Model EA113 Electronic Avo, £96.00; Model 272 Electronic Avo, £34.30; Model TT169 Transistor Testor, £20.06. All above post free in U.K. Trade and Educational enquiries invited. All other AVO and TAYLOR products available, ask for quote.

**S. G. BROWN'S HEADPHONES.** Type "F" 120 ohm, 2000 ohm, 4000 ohm, £10.80 (50p); Rubber Earpads for same, 70p per pr. (10p); Standard Jack plugs, 24p (4p).

**EDDYSTONE EQUIPMENT.** Please enquire.

**CODAR EQUIPMENT, PR40, £11.00 (60p).** Leaflets on request.

In present conditions we regret that all prices are subject to alteration without notice.

**NOTE:** 8% VAT must be added to all prices, new and secondhand, inc. carr. and packing.

Carriage for England, Scotland and Wales shown in brackets, Terms: C.W.O., Approved Monthly Accounts, Hire Purchase and Part Exchange. Special facilities for export.

At R.T. & I.

- ★ We have full H.P. facilities.
- ★ Part exchanges are a pleasure.
- ★ We purchase for cash.
- ★ We offer a first-class overhaul service for your electronic equipment, whether you are an amateur or professional user.
- ★ We have EASY Parking facilities.
- ★ We welcome your enquiries for specific items which although not advertised, may very well be in stock.

**FREE SHURE MIC. WITH EVERY KW TRANSMITTER or RECEIVER purchased**

**PARTIRIDGE "JOYSTICKS."** "New Lightweight VFA" £12.10 (60p); "JOYMATCH" III, Aerial Unit, £12.10 (60p), LO-Z500, £17.60 (60p); ATU kit, £5.00 (50p); ATU assembled, £6.05 (50p); Artificial earth; £6.00 (50p); Aerial Bandswitch, £6.00 (50p). Literature on request;

**TRIO EQUIPMENT.** Please enquire.

**SHURE MICROPHONES, 444T, £15.00 (40p); 444, £13.00 (40p); 401A, £6.50 (30p); 201, £5.40 (30p); 202, £6.00 (30p).** Full details on request.

**KEYNECTORS,** piano key mains connector units, £4.25 (40p). Trade enquiries welcome.

**VALVES.** Please state your requirements.

**ADVANCE TEST EQUIPMENT**—we are agents—your enquiries please.

**TMK METERS:** TM500, £13.75 (50p), TW20CB, £17.50 (50p), TP55N, £9.75 (50p), Model 700, £30.00, also cases for same.

**PHILIPS PM2403 ELECTRONIC MULTIMETERS, £53.00 (60p), etc., etc.**

We also supply **PHILIPS & LABGARE COLOUR TV TEST EQUIPMENT,** including Colour Bar Generators, Cross Hatch Generators, Degaussing Coils, Oscilloscopes, CRT Testers, Transistor Testers, etc., etc.

**KW EQUIPMENT:** (Don't forget your FREE mic. with every Tx. and Tscr. I). KW2000E & P.S.U., £342.00 (£3.50); KW202, £195.00 (£2.50); KW204, £250.00 (£3.00); KW1000 Linear, £180.00 (£4.00); KW107, £68.00 (£1.50); KW E-Z MATCH, £22.00 (80p); KW160, £18.00 (80p); KW109, £78.00 (£1.50); REMOTE VFO for Atlanta, £38.00 (70p); KW103 Monitor Scope, £85.00 (£3.00); Speaker for KW202, £13.00 (50p); KW103, £16.00 (50p); KW Low Pass Filter, £10.50 (30p); KW Antenna Switch, £6.00 (25p), etc., etc.

# R. T. & I. ELECTRONICS LTD.

Ashville Old Hall, Ashville Road, London, E11 4DX Tel : 01-539 4986  
NEAREST STATION: LEYTONSTONE (Central Line)

## CRYSTALS: Still 1000's in stock per previous adverts

<b>TX, 4 x 150A's</b> in parallel P.A. Blown, Pi tank, 70 ohm output, 70 ohm input, 2 volts RF carrier or SSB into 6CH6 then 5B254M (min. 807) driver. First 2 stages linear, 4 x 150A's can be biased AB or C to suit mode. Gang tuned by inductors calibrated 2-8-18 MHz, will go up to 30 MHz if some capacitors removed. Also has switched metering and 2 switched crystal positions for CW or AM. Maximum output power 400W SSB or CW, 280V AM. Power requirement 600-1200 volts HT, 300 volts MT, 24 volts heaters, bias, relays and blower. With circuit and 2 crystals. Size: 8 x 8 x 12	£20.00	
<b>COLLINS MODULATOR UNIT</b> up to 130 watts AF from push pull 6159's (sim. 6146) driven by 250mV into 5751 and 5814 amps and 5726 clipper 300-3000 6dB filter. Power required, 600-750 volts HT, 250 volts MT, 24 volts heaters—60 volts bias. With circuit. Size: 5 x 3 x 6	£12.00	
<b>COLLINS RF/IF AMPLIFIER UNIT</b> all permeability tuned, 2-25 MHz, 2RX RF stages 5749's, first and second mixers 5750's, 5749 first IF tuned 2-3-75 MHz, IF output 250 kHz. First and second TX mixers 5750's, tuner and multiplier 5654's, drivers 2 5686's, 4 tuned circuits at signal frequency. Power required, 250 volts HT, 24 volts heaters. With circuit. Size: 6 x 7 x 8	£15.00	
<b>COLLINS 250 kHz IF UNIT</b> mechanical filter, 3 stages 5749's also AVC, Det, NL, 2 5726 double diodes. Power required, 250 volts HT, 6, 12 or 24 volts heaters. With circuit. Size: 3 x 5 x 6	£15.00	
<b>COLLINS 250 kHz OSCILLATOR UNIT</b> 5749 crystal osc., 5749 varactor tuned L/C osc. both at 250 kHz for drive and BFO. Power required, 150 volts HT, 6 or 12 volt heaters. With circuit. Size: 1 1/2 x 6 x 5	£10.00	
<b>COLLINS MOUNTING CHASSIS FREE TO PURCHASERS OF SET OF UNITS</b>		
<b>COLLINS, MUCH MORE FOR MARINE, AERONAUTICAL AND AMATEUR CONVERSION IN STOCK</b>		
<b>VHF TX BY COLLINS TYPE 17L-4.</b> QQV06-40A PA and stages which could be modified to use as mixer. With 4 channels between 118 and 135-95 MHz	£40.00	
<b>STORNO QCM39 4 METRE FM TX/RX VISCOUNT AS DESCRIBED IN APRIL RADCOM.</b> Ready converted and aligned with a pair of crystals from our advertised stock. 10 watt output, QQV03-10 PA, transistor IF, AF and 12 volt + or - PSU. Deviation adjustable up to 5 kHz. Relay for second channel supplied, up to 8 may be fitted. Circuit of tone unit. Boot mount with mic, control, speaker and cables. Power, 1 amp RX, 6 amp TX. Size: 4" x 10" x 13". Weight: 15lb.	£30.00	
<b>145 MHz TX PA AND DRIVE UNIT.</b> QQV06-40A, 5763 doubler, 5763, 5686, 6AU6 valves, all stages gang tuned, size 11 x 4 x 5	£15.00	
<b>UHF RX</b> with 2 x 3 section through lines 4 1/2" long, double superhet 54 and 6-9 MHz, B7G, B9A valves. Size: 8 x 17	£5.00	
<b>70 MHz AUTO ALARM RECEIVERS,</b> flashing light and audio tone outputs, 3 tone filters in some for selective calling. Several types available from	£3.00	
500 or 500 micro amp meter unit	.9H 200mA potted choke	Choke 20 core /3m.
500 micro amp 1 1/2 inch meter	Vanguard covers /pair	Cable 12 core /4m.
QQV03-20A, 06-40A bases p 3	45 MHz IF unit, 6 valves	Cable 6 core /6m.
Boot Ranger leads and plugs	30 amp hash filters	Cable H.D. twin/10m.
Co Ax 75 ohm UR203/10m.	8mf 800v. capacitors	Mod. Trans. 100 watt
All above £2 each including post U.K.	Boot Ranger con unit.	Mod. Trans. 20 watt
	Co Ax 75 ohm UR70 /10m.	80, 40, 20, 15 Tx tuner

ALL PRICES INCLUDE CARRIAGE ENGLAND. SAE ALL ENQUIRIES

# BAGINTON ELECTRONICS

(G3TFC)

COVENTRY AIRPORT  
Phone (0203) 302449  
or 302668

# THANET ELECTRONICS

DAVE  
G8ELP



PAUL  
G3VJF

IC-210

## UK INOUE IMPORTERS

IC-210 STILL AVAILABLE AT THE AMAZING LOW PRICE OF £200.00 + VAT

We are still able to offer the IC-210 at this bargain price although this situation is not likely to last much longer. If you are thinking of taking advantage of this offer we would advise you to act quickly or you may be too late. The 210 is fully VFO on both transmit and receive and is stable as a rock because it uses a special phase-locking technique whereby the 11 MHz superbly built VFO is not multiplied. In addition 3 spot crystal frequencies can be used (145 MHz is already fitted). The Duplex facility automatically drops the Tx frequency by 600 kHz and introduces a tone-burst thus making the rig usable through all proposed UK repeaters. Operation is from built-in mains PSU or 12v. neg. earth. A built-in 50 kHz crystal calibrator and centre-zero meter makes netting easy and accurate.

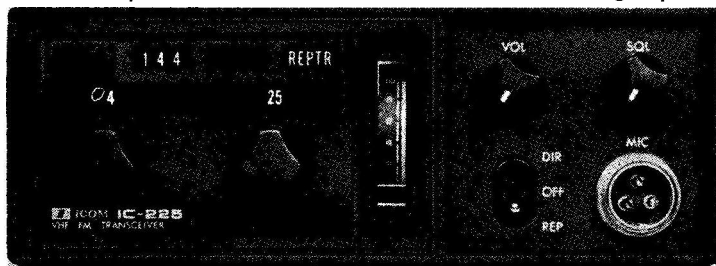

IC-225

This superb 80 channel FM mobile transceiver is becoming extremely popular. It uses a phase locking technique giving 80 channels at 25 kHz spacing all packed in a case 58 mm. x 156 mm. x 247 mm. Other "in-between" channels can be obtained by use of another crystal (e.g. 144.48). The same Duplex facility as that used in the 210 is fitted and a tone burst is automatically inserted when switched to "Repeater." Thus the IC-225 can be used on all proposed UK repeaters without having to buy further crystals. The price is £195 + VAT.

**IC-22.** The IC-22 is the ideal low-priced mobile rig for the man who prefers to increase the number of channels he has available by buying extra crystals when he can afford them. It comes fitted with an automatic tone burst which operates only on selected channels, i.e. those fitted with repeater crystals, without having to turn any switches or press buttons at the right time while driving at 70 m.p.h. When operating on simplex channels the tone burst is automatically switched out. It has a total capacity of 22 channels and comes fitted with SO, S20 and S22 included in the purchase price of £109.26 + VAT. At the time of going to press we have crystals in stock for all the UK repeater channels at £4.00 per pair + VAT. The receiver sensitivity is excellent (0.4uV in 20 dB quieting) and the audio quality and clipping ideal for both repeater and simplex working. We check all our transceivers before dispatch and set up the deviation correctly. You won't be making a mistake by getting a 22 if you can't afford a 225—ask anyone who has one.

**IC-3PA.** This is a mains PSU and extra loudspeaker made to operate the 22 or the 225. It comes supplied with a cradle to hold either transceiver and has built-in automatic current overload protection and warning lights. It will easily give 3 amps at 13.6v. and is ideal for converting your mobile rig into a base station. The price of these has now been reduced to £35 + VAT.

TRADE ENQUIRIES WELCOME

24-HOUR  
ANSAPHONE  
SERVICE

## THANET ELECTRONICS



3 SHEPPEY VIEW, WHITSTABLE, KENT, CT5 4PG. Tel.: (02272) 62555

Northern Agent: Mr. Peter Avill, G3TPX, 7 Moorland Crescent, Mapplewell, BARNESLEY.  
Tel.: Darton (022-678) 2517 By appointment evenings and weekends.

# DERWENT RADIO

5 COLUMBUS RAVINE, SCARBOROUGH Tel. SCA 65996

Showroom open Tuesday/Thursday/Friday/Saturday

SEE THE NEW ATLAS 180 IN SCARBOROUGH

KW 2000E transceiver ...	£373-68	RCA	3N 140 & 141	80p
KW 202 receiver	£214-38		40673	60p
KW 204 transmitter	£273-78		BC107/108/109	12p
KW 107 matching unit	£74-31	Dosemeters	...	12p
KW E-Z match	£24-41	10PF variable capacitor	...	25p
KW Balun	£3-46	50PF Differential	...	19p
KW Aerial switch	£6-70	50pf two gang	...	85p
Barlow Wadley XCR	£125-00	All "G" Beam aeriels	...	
Atlas 180 transceiver	£280-00	stocked.		
We try to keep a full range of the following makes in stock and will accept trade in goods against any items:		Lilliput lamps, 6v. or 12v.	8p	
Microwave Modules, Solid State Modules, "G" Beam Antennas, "G" Whip Mobile Aeriels.		Large Car Type crocs...	8p	
TE15 GDO	£20-00	Mono/stereo head-phones	£3-10	
2,000 ohm headset	£1-40	Decon printed cct. pen	95p	
1-20v. D.C. p.s.u. 1A stab	£1-80	300 ohm twin feederyd.	8p	
2 1/2" speaker 8 ohm	38p	Telephone pick-up coil	48p	
3" speaker 8 ohm	48p	Veroboard assortment	60p	
Aluminium Cabinets:		Veropins 1 or 15	17p	
9 1/2" x 4 1/2" x 3"	98p	Egg insulators	9p	
7 1/2" x 4 1/2" x 3"	82p	Panel "S" meter 2"	£1-80	
5" x 4 1/2" x 1 1/2"	—	R substitution box	£1-80	
Wightraps standard	£3-48	C substitution box	£1-65	
Wightraps high power	£4-90	Carbon breast mic.	40p	
Shure 201	£6-50	Panel mains neon	20p	
Dynamic 50K ohm P.T.T.	£3-95	Meter test prods and leads	38p	
"G" Beam Halo	£1-62	In line fuse holder	8p	
50 resistors	17p	20mm. fuse links 500ma to 3A	2p	
50 1/2 resistors	12p	36" chrome Whip aerial	44p	
50 capacitors	55p	56" chrome Whip aerial	88p	
50 disc ceramics	33p	Mini push switches	13p	
20 wire wound resistors	15p	All boxes 2 1/2" x 4" x 1"	30p	
10 mixed potentiometers	50p	2 1/2" x 4 1/2" x 1 1/2"	33p	
10 mixed wafer switches	40p	2 1/2" x 4" x 1 1/2"	35p	
10 croc. clips	50p	2 1/2" x 3" x 1 1/2"	30p	
Mixed sleeving pack	15p	7 1/2" x 4" x 1 1/2"	35p	
14 and 16way DIL sockets	20p	7 1/2" x 4" x 1 1/2"	35p	
Amphenol SO239	40p	3" x 5" x 1 1/2"	38p	
Amphenol PL259	40p	7 1/2" x 5 1/2" x 2 1/2"	55p	
SO239 single hold fixing	40p	9 1/2" x 6 1/2" x 2"	80p	
Reducer	10p	Wander plugs black or red	5p	
Transistors 2N3819	38p	Phone plugs black or red	4p	
2N3053	26p	Phone plugs	7p	

HAM RADIO MAGAZINE. We have several hundred copies of various back numbers in stock at 35p each. S.A.E. FOR LIST.

ODD CRYSTALS. The following freqs available for clearance at 40p each or 3 for £1. Only one of each so please enclose s.a.e. for return of cash if necessary. Freqs in kHz. 125 150 192 192-03 1065 1800 2060 2100-3 2142 2132 2104 2210-8 2250 2285 2295-83 2350 2500 2850 1800 2700-5 4024 4124-6 4336-1 4350 4351-39 4355-56 4372-22 4580 4721-528 4788 2 5146-875 5429-4 5500 5520-62 5541-67 5993-33 5993-75 5967-08 5854-17 5979-58 5968-75 6000 6010 6021-11 6048-9 6066-23 6076-67 6079-17 6096-25 6110 6154-44 6200 6253-75 6400 6500 6504-17 6516-67 6527-08 6629-17 6537-5 6554-17 6556-25 6610 6800 6888-54 6915-55 6968-75 706215 7066-25 7072-92 7210 7260-42 7420 7613-13 7666 7697-9 7706-08 7722-5 9000.

QSL CARDS. 10p stamp for quality samples and price list.

9R59DE owners. We have an 8 ohm loudspeaker with suitable bracket for internal mounting in your receiver. Fixed in 10 minutes. 85p. WE ARE LOOKING FOR GOOD CONDITION MODERN TRANSMITTERS AND RECEIVERS ETC. AND WILL PAY CASH OR GIVE GOOD TRADE-IN PRICES. PLEASE LET US HAVE DETAILS WITH S.A.E. FOR OFFER. DES WOOD, G3HKO.

### QSL DISPLAY POCKETS

These are plastic strips of 12 pockets for the vertical display of your QSL cards. 10 strips cost 44p including postage.

Second hand equipment:

Pye lowband whip only	40p	KW 2000A and AC p.s.u.	£170-00
(Carriage 40p, any number)		Yaesu DC p.s.u. (FT200)	£45-00
KW 202 receiver	£185-00	Yaesu FT401DX	£200-00
KW Viceroy IV	£75-00	Yaesu FV401 cfo	£35-00
Pye lowband base Tx	£12-00	Yaesu SP401 speaker	£8-00
Pye transistor base Rx	£14-00	Trio 9R59DS	£48-00
Pye Vanguard no cables	£6-00	Trio SPS speaker	£3-50
Pye 6 channel ranger	£8-00	Trio JR310	£70-00
Pye lowband Cambridge	£14-00	Trio SP10 (for 310)	£5-00
Collins 75S1	£166-00	Trio JRS99	£120-00

Secondhand equipment. As stocks are changing from day to day we do not find it worth while including a full list in our ad. However a S.A.E. will bring our latest duplicated full list. Please ask for our components and equipment stock list also.

WANTED—50 Yaesu FR50B receivers

For receivers in top condition and complete with carton and hand-book, cash offer of £40.

WANTED any clean copies of "Newnes Radio and TV Servicing" from 1963 onwards. S.A.E. with details please.

PLEASE ADD EXTRA FOR CARRIAGE, S.A.E. FOR LISTS ALL PRICES INCLUDE V.A.T.

## SMALL ADVERTISEMENTS

("SITUATIONS" AND "TRADE")

6p per word, minimum charge £1.00. No series discount. All charges payable with order. Insertions of radio interest only accepted. Add 50% for Bold Face (Heavy Type). Box Numbers 15p extra. No responsibility accepted for transcription errors. Replies to Box Numbers should be addressed to The Short Wave Magazine, 55 Victoria Street, London, SW1H 0HF.

### TRADE

6146 Valves: British Made: New and boxed, guaranteed, not surplus. Price £2-75 each, inclusive, cash with order.—A. E. White, G3HCU, QTHR, Tel: Dorking 730 215.

Quality QSL Cards: Rush orders welcome, s.a.e. for samples.—Compalith Printing Services, 115 Promenade, Cheltenham, Glos., GL50 1NW.

Wanted: Eddystone 770R receiver in good condition.—Ring Western Electronics, Southampton 27464.

Amidon-Europe: All toroid cores and ferrite beads in stock, sizes 0.25 to 2.0 in., mix two/six and others. Send one IRC for price list.—E. Ruschmann, c/o DJ7PO, Im Heldenrecht 9. d-76 Offenburg, West Germany. No minimum on orders, we deliver all over Europe, and you can write in English, French or German.

Mosfet Front-End Converter: Input 118-150 MHz, output at 10.7 MHz. Send £9-85 (includes VAT and post/packing) to: Reedhampton, Ltd., 182-184 Addington Road, Selsdon, Surrey, CR2 8LB.

JR-310 Owners: Top Band conversion kits, £6-99. Xtals for 29.5 to 30.1 MHz, £3-30. Mechanical filters, CW or SSB, £16.00. Suitable headphones, £5-50. All post and VAT paid.—G3LLL, Holdings, 39-41 Mincing Lane, Blackburn, Lancs., BB2 2AF. (Tel: 59595/6).

Microphone Bargains: VAT and post paid. Shure 444, £13-99; Shure 201, £4-99. Acos inserts, two for £1-75. FR-101 and FT-101, get them at Holdings, the RF Clipper people. G3LLL, Holdings, 39-41 Mincing Lane, Blackburn, Lancs., BB2 2AF. (Tel: 59595/6).

Hand-Portable FM Two-Metre Equipment: A limited quantity of G.E. equipments will be available within the next 3-4 months. To gauge your interest, please send s.a.e. for details. Price will be in the region of £35.—J. D. Harris, G3LWM, c/o R.S.L. Components, 52 Silver Street, Stansted, Essex.

Antennae: G-Whip, J-Beam, 18-AVT, HQ-1.—Holdings, 39-41 Mincing Lane, Blackburn, Lancs. (Tel: 59595/6).

QSL Cards: And GPO-approved Log Books. Also headed notepaper. Send 5p s.a.e. for samples.—Atkinson Bros., Elm Tree Press, East Loose, Cornwall, PL-13 1JT.

May Issue: Due to appear April 25. Single copies at 40p post free will be sent by first-class mail for orders received by Wednesday, April 23, subject to supplies being available.—Circulation Dept., Short Wave Magazine Ltd., 55 Victoria Street, London. SW1H-0HF.

QSL Cards: £4-75 per thousand. Send s.a.e. for samples.—Chas. Baker, 52 Roundwood Road, St. Leonards-on-Sea, Sussex.

QSL Cards: From £1-15 per 200. Log Books from 32p, prices inclusive post and VAT. Send 7p stamp for details.—Rallymaps of West Wellow, P.O. Box 11, Romsey, Hants.

**READERS' ADVERTISEMENTS**

3p per word, minimum charge 50p payable with order. Add 25% for Bold Face (Heavy Type). Please write clearly, using full punctuation and recognised abbreviations. No responsibility accepted for transcription errors. Box Numbers 15p extra. Replies to Box Numbers should be addressed to The Short Wave Magazine, 55 Victoria Street London, SW1H 0HF.

**READERS**

**For Sale:** Swan 500CX with power supply and external CW/SSB audio filter control unit, excellent condition, £250 the lot. Also brand new Nombrex 42 signal generator, £15.—Ring Goodbody, 01-592 7800.

**Selling:** Property of the late G4TZ: Drake R4-B, £150; 50-ft. lattice mast with guys and TR-44 rotator and control unit, £45 or near offer; Type TTL-2 RTTY terminal unit as shown on p. 5-13 of "Teleprinter Handbook", £50; Creed 54 teleprinter with perforator, £20; or ditto without perforator, £15. 80-plus-80v. PSU, £5; Teletype TD-14 tape sender, £8; Type 85R printing reperforator, £8; K.W. dummy load, 75-ohm, £3; DX-100U transmitter stripped for RTTY, £25; ATE FS keyer FSK-2, £9; Pye PTC-331 two-metre base station Tx, £12.50; Withers converter, 144/28 MHz, £6; RTTY machinery and some items might be donated to genuine invalid radio-amateur, or youth training project.—Addie, G8LT, Spring Hill, Wappenham, Towcester, Northants.

**Sale:** Cossor Commando Tx/Rx, VHF/AM, 50-watt, £40. Creed 7E teleprinter, £20. Murphy VT-51A high-power 2m. Tx, offers? AR88D, working but selling for spares, £10. 144 MHz Tx output filter, £2. BRT-400D Rx, £35. 4CX250B with base and chimney, £8. QQVO/640A, £1.50. 240v. AC motor, 1 r.p.m., £4. 1/8-H.P. DC motor, £5. SCR DC motor control, £3. 1 MHz crystal with 6/12v. oven, £4. Dynamic mic. on stand, £3; p-t-t mic., 300-ohm, 50p. Headphones with boom mic., £5. Electroniques 1.6 MHz coil pack, £2. 1.6 MHz, 4.0 kHz B. & W. SSB filter, £4.—Ring Harper, Hatfield 71310 (evenings).

**Wanted:** SB-310, or similar SW/Broadcast bands Rx; also "Radio Communications Handbook"—Engel, CUMAS, 16 Bvd. D'Aguillon, 06600 Antibes, France. **For Sale:** Yaesu FR-101 de luxe, brand new, with guarantee and speaker, £330.—Condon, 33 Kimbolton Green, Borehamwood, Herts.

**Wanted:** Miniature Heathkit 'scope. Details and price please.—Conelly, G3UXE, 19 Norfolk Road, Maidstone (S0583), Kent.

**Bargain Clearance:** FL-200B Tx, 3.5 to 28.0 MHz, £65 or near offer. K.W. Vanguard Mk.II Tx, 1.5 to 28.0 MHz, £25. Codar Tx/Rx with all cables, control box etc., for mobile rig, £25. Ultra Tx/Rx, two-metre, separate, £20. No. 19 Set Mk.III, Canadian, all cables, two PSU's includes vibrator for Rx, £18. TA-32Jr. beam, £13. Carriage extra.—Ring Hewitt, G3SGH, Ashford (Kent) 21158.

**Sale:** FL-2100 with one spare 572B, £150. IC-20 fitted with 9 channels, 1/2-wave G-Whip, £85. 12v. DC input PSU's; s.a.e. for details.—Wake, G5RP, College Farmhouse, West Hendred, Wantage, Oxon, OX12 8RP. (Tel: East Hendred 384).

**For Sale:** SX-117 with HT-44 and PS150/120, £175. 60-ft. Versatower autowinches, not used, £120. Buyer collects. Two Ham-M controllers, £55. HO-10, £25. HO-13, £30. SB-610, £50. SB-620, £75. Osker SWR-200, £12. FT-101 Mk.II, with CW filter, fan, FV-101 and SP-101P, £250.—Surman, G3FPD, QTHR. (Tel: Loxwood 752141).

**Sale:** Crystals, two-metre in 25 kHz segments (144-200 and 145.150 already sold). Would consider 80 metres in part-exchange. Offers?—Knight, GM8FFX, P.O. Box 49, Aberdeen, Scotland.

**NORTHERN RADIO SOCIETIES ASSOCIATION**

**Annual Convention BELLEVUE - MANCHESTER**

SUNDAY, 27th APRIL

commencing at 11 a.m.

- Trade Stands                      Club Display Stands  
Inter-Club Quiz                      Grand Raffle  
Other Demonstrations  
Construction Contest  
Clubstand Trophy  
Talk-in Stations SSB G3WDH (Top Band)  
and 2m AM/FM, GB3NRS

The entrance to the Exhibition Hall is at the rear of Bellevue opposite main car park (off Hyde Road A57)

**REG. WARD & CO. LTD. (G2BSW)**

WE ARE OFFICIALLY APPOINTED K.W. AGENTS FOR THE SOUTH WEST (Somerset, Dorset, Devon, Cornwall)

KW 160 Top band A.T.U.	£18.00
KW 108 Mon. scope	£85.00
KW 2000E TCVR ; A.C. p.s.u.	£342.00
KW 202 Receiver with matching speaker	£208.00
KW 204 Transmitter	£250.00
KW 101 VSWR Meter (52 or 75 ohm)	£8.42
KW 103 VSWR Meter and Combined Power Meter	£16.00
KW E-Z Match, 10-80m. ATU	£22.00
KW 107 Combined E-Z Match, VSWR and R.F. Power Indicator, Dummy Load and Antenna Switch for 4 Outlets	£68.00
KW109 High Power ATU etc.	£78.00
KW Trip Dipole Coaxial Feeder	£26.00
KW Trap Dipole with Balun	£29.00
KW 3-way Antenna Switches (for coax)	£6.00

**YAESU**

Yaesu FT101B Tcvr.	£330.00
Yaesu FR400 DX	£148.00
FT200 Transceiver and FP200 A/C PSU	£215.00
Yaesu FT 201 Transceiver	£290.00
Yaesu FR101S RX	£245.00

Sentinel 2m. Preamps and 2m. Converters/Europa Transverters.

**SHURE MICROPHONES**  
Model 44, £18.50; Model 201, £5.70.

**USED EQUIPMENT**

Park Air 2m. TX 4 XTAL channels. Comp. with H/book, spare valves and Shure desk mic.	£69.00
Eddystone 750, inc. speaker and S meter	£40.00
Star SR.550 RX	£45.00
Star SR.200 RX	£36.00
KW 202 RX, reconditioned, including speaker	£165.00

VALVES for YAESU, etc. 6BM8, 6BZ6, 6G8, CE17, 6AV6, 6KD6, 12AX7A, 12BY7A, 12AU7, R.C.A. VALVES for KW and Heathkit equipment. 6146, 6146B, 6HF5, 6LQ6, 6GES, 6EA8, 6GWB, 6CK6, 6CM6, 6CL6, 6CB6, 6BN8, 6H56, 6EW6, 12BA6, 12BE6, 12B26, 6J56C, etc., and many other types.

J Beams and Stolle Rotators : 140ft., 14g. enam. copper ant. wire ; Ribbed and T-Insulators ; 52 and 75Ω co-ax, and U.H.F. plugs and sockets. Mast Couplers for 2in. Masts.

TRADE INS WITH PLEASURE. OUR STOCK OF GOOD SECOND HAND EQUIPMENT CHANGES DAILY—LET US KNOW YOUR REQUIREMENTS.

Due to currency fluctuations prices of imported equipment are liable to alteration. Add 8% VAT to all prices except used equipment. HP TERMS AVAILABLE CARRIAGE EXTRA ON ALL ITEMS

**AXMINSTER - DEVON**





### FIRST CLASS ANTENNAE FOR MOBILE AND PORTABLE COMMUNICATION

2 metres : +4dbD 5/8 wavelength.

A5-6 (with hinge base) ... .. £5.19 (inc. VAT)  
A6-5 (with screw base) ... .. £5.12 (inc. VAT)

Wide range of helical antennae for portable communication : many different terminations.

#### LARGE S.A.E. FOR CATALOGUE AND PRICE LISTS

N.B.—We regret to announce an 8% price increase across the board, effective from 1st April, 1975.

**ANTENNA & ELECTRONIC CONSULTANCY CO. LTD.**

74 Upper Sherborne Road, Basingstoke, Hampshire  
Tel.: Basingstoke 27527

### FT.101 Mark 1, Mark 2 and "B" OWNERS— WHY RF CLIPPING?

Normal mic lead type clippers generate harmonics. (Clip 500 Hz and you get 1 kHz, 1.5 kHz, 2 kHz, 2.5 kHz, etc.) These distortion products waste TX power, clutter up the audio channel, and reduce clarity of speech.

G3LL's RF Clipper clips the FT.101's SSB signal at the I.F. frequency of 3.180 MHz. All harmonics, being radio frequency, are removed and no audio harmonic distortion is produced. Processed signals is passed through second SSB filter to remove any out of channel intermodulation products.

RF Clipping has been "plugged" by the A.R.R.L. Handbook for years—we've just made it easy for FT.101 owners. Run the equivalent of a kilowatt mobile, or at home without a linear!

Improved RX performance is achieved by wiring Clipper SSB filter and extra gain into circuit on receive.

Full details:

G3LL, HOLDINGS LTD.,

39/41 Mincing Lane, BLACKBURN, BB2 2AF. Tel.: 5995916

### IRON POWDER TOROIDAL CORES

CORE No.	2 Mix Red	6 Mix Yellow	10 Mix Black	12 Mix Grn/White	OD"	ID"	TH"
	50k-30MHz $\mu = 10$	10-90MHz $\mu = 8$	30-150MHz $\mu = 7$	60-200MHz $\mu = 5$			
T-200	£1.35	1.90			2.000	1.250	550
T-130	.90	1.12			1.300	.780	437
T-106	.45	.70			1.060	.560	437
T-80	.30	£0.40			.795	.495	250
T-68	.22	.28	£0.34		.690	.370	190
T-50	.20	.22	.26	£0.28	.500	.303	190
T-37	.18	.20	.21	.24	.370	.205	128
T-25	.14	.16	.18	.20	.210	.120	128

#### TOROID CORE KITS

TK-101 contains 8 T-50-2 7 T-68-2 £2.40

TK-102 contains 7 T-50-6 6 T-68-6 £2.45

TK-103 contains 4 T-50-2 4 T-50-6 3 T-68-2 3 T-68-6 £2.40

Balun kit makes a 1:1 or 4:1 1kW balun, with instructions, £2.00

P. & P. 20p on all orders. Data sheets and enquiries send s.a.e.

Also in stock:

Osker SWR/Pwr. Meters, W2AU Baluns, HQ-1 Mini-Beams, etc.

T.M.P. ELECTRONIC SUPPLIES

3 BRYN CLYD, LEESWOOD, MOLD, CLWYD, CH7 4RU

Tel.: Pontyodkin 846 STD 035 287

## P.M. ELECTRONIC SERVICES

### CRYSTALS FOR PROFESSIONAL AND AMATEUR USE

We can supply crystals to most commercial specifications, with an express service for that urgent order.

For the amateur we carry a large stock of the more popular frequencies, backed by a quick service for those "Specials." See last months *Short Wave Magazine* for full lists.

Please send S.A.E. for details or telephone between 4.30-7 p.m. and ask for Mr. Norcliffe.

7A ARROWE PARK ROAD, UPTON, WIRRAL.  
MERSEYSIDE L49 9UB

Tel: 051-677 8918 until 7 p.m. Cables: CRYSTAL BIRKENHEAD

**Wanted:** Trio 9R-59DE in good condition. Will offer up to £38.—Ring Luttrell, Leicester 706023 evenings.  
**Wanted:** R.107 Rx in good working order. Details and price please.—Kirk, 110 Meadow Road, Beeston, Nottingham. (Tel: Nottingham 257396 after 5 p.m.).  
**Wanted:** General coverage communications receiver in good condition. Details and price please.—Neate, 106 Sandling Lane, Maidstone, Kent. (Tel: 0622-63674).

**Sale:** 9 MHz S.E.I. QC-1246AX SSB filter with carrier xtals (cost £20 new), accept £14.—Hamer, G3LMQ, 7 Arundel Road, Cheylesmore, Coventry.

**Wanted:** FL-2000 Tx, must be in good condition.—Ring Forsyth 0721-20050 (Peebles).

**Selling:** FT-75 with DC-75, £110. Creed 75RP Mk.IV with reperforator, £50. Solartron Type CT-386A oscilloscope, £60. DVM DM2003, £30. Pair of walkie-talkies working on 28.5 MHz, superhet Rx, £25. All with manuals. Delivery possible.—Ring Purser, G2AXO, 0604-61794 (Northants). QTHR.

**Exchange:** Pye C.A.T. Marine general coverage receiver, 8 bands covering 60 kHz—31 MHz, with PSU, speaker and handbook etc., For Trio 2200 or similar 2m. FM rig.—Phipps, 47 Dean Road West, Hinckley, Leics. (Tel: Hinckley 36811 weekends).

**For Sale:** Multi-2000, mint condition, in original carton, £220. Yaesu FR-400SDX, coverage 160-2m., mint condition.—Ring Kellett, Leicester 885833. (G8HMJ, QTHR).

**Thank You** Gloucester gentleman for S.38 diagram. Baby ate your address!—Elam, 8 Adelaide Road, Redruth, Cornwall.

**Selling:** AR88D, no mods., with S-meter, circuit, matching speaker, perfect condition, £40.—Price, 2 Harcourt Road, Westbury Park, Bristol.

**Sale:** Galaxy Mk. IV transceiver, 400-watt. with mobile PSU, manual and spares, £165.—Ring Purser, G2AXO, 0604-67194 (Northants). QTHR.

**Sale:** Eddystone 680X, £65. Crystal filter, variable selectivity.—Dummett, 67d Shooters Hill Road, London, SE3 7AU.

**Museum Piece:** W.W.II Japanese infantry transceiver, working recently, complete except for power supply. Offers?—Buxton, 71 Carlisle Road, Eastbourne, Sussex.

**Wanted:** Old KW-2000 Tx/Rx, anything considered. Details and price please. Also braided dinghy aerial wire as used with ex-R.A.F. box kites.—Fawkes, G3VQW, 6 Oak Avenue, Brickfields, Worcester WR4 9UG.

**Wanted:** 5FP7 CRT for slow-scan monitor, and AR88D handbook.—Morris, G4CTR, 188 Sandbanks Road, Poole, Dorset.

**Selling:** Marconi CR-300 receiver, £10. **Wanted:** HRO receiver, complete or incomplete; SSB exciter phasing or filter rig, commercial or home-built.—de la Bertauche, G3RCO, QTHR. (Tel: Seaton 21016).

**For Sale:** Trio 9R-59DS receiver with crystal check, mint condition, £39. K.W. Vanguard transmitter, with 160-metre coverage, excellent condition, £20. Buyers collect, or would deliver up to 50 miles.—Ring Frost, G3GNL, 01-462 3287.

**Selling:** Sommerkamp FL-DX500, £110. Trio JR-500S, £40. Both in good condition, little used, and with handbooks.—Burr, G3NBT, QTHR.

**Sale:** AM-25B with xtals for 70.26 MHz, £8. High-Band AM-25T, £20. FM Cambridge, £25. U450L 70cm. Tx, £8. 70cm. mobile rig (similar to Cambridge) with xtals for 432.2, £15. Marconi Type TF-801 signal generator, £10. K6AXN trough lines for 23cm., £6. Teletype 14 teleprinter, £5. Eddystone EB-35 Rx, £45. Low-Band AM-10D, £20. KW-2000A, £150. Send s.a.e. for more information.—Robertson, Toll House, Stretham, Cambs.

**For Sale:** "G3TDZ" two-metre receiver, completed less variable capacitor, £11.—Hay, G8GUD, QTHR. (Tel: 021-744 5675).

**Sale:** Two metres: HW-17A with many crystals, manuals, mobile PSU, excellent, £50. Bug key, £15. Pye Cambridge, Vanguard. Offers?—Ring Morse, GM8EIR, at Cheltenham 23179.

**Offering:** Trio TS500/PS500, new, Offers? **Wanted:** Pye Westminster FM Hi-Band; Marine radiotelephone, VHF or MF; Pye Cambridge-series receiver RF boards or part complete sets. Details and price please.—Austen, 28 Valebridge Road, Burgess Hill (3409), Sussex.

**For Sale:** Codar CR-70A receiver, latest model with matched speaker, £29. Prefer buyer collects.—Potter, 37 Wykeham Hill, Wembley, Middlesex, HA9 9RY.

**Selling:** Collins KW-M2A transceiver with power supply, extra speaker and novice adapter, seldom used, £550. Collins 30L-1 amplifier, used six hours only, £240. Collins headset, unused, £15. Will sell separately.—Ring Goodbody, 01-592 7800, business hours only.

**Sale:** 14-AVQ plus LCQ-80 metres, loading coverage for 80-10m., £20. R.209 Rx, £15. Bird Type 43 wattmeter, £40. HRO-type Muirhead vernier dial and gears, £10. 1000pF and 500pF, 10 kV., Tx ceramics, £1 each post paid. VHF power transistors, s.a.e. please. **Wanted:** Trio linear or W-H-Y? Exchange for gear (W-H-Y?) welcomed.—Hunter, 01-858 1448. (London).

**Sell or Exchange:** Eddystone 888 Rx, less A/F filter, with S-meter and circuit, very good condition, £45. Want JR-500SE or HA-350.—Ring Handy, Coventry 22201.

**For sale:** Trio 9R-59DS Rx in mint condition, with speaker, £30 or near offer. Codar CR-70A Rx with PR-40 preselector and speaker, in mint condition, £20 or near offer.—Ring Roebuck, New Milton 616702, Hants.

**Selling:** Almost unused Skywood receiver, £24; have bought new transceiver. Two-metre converter, faulty, £2.50. Butterflies, 12pF and 25pF, 60p.—Ring Smith, 01-684 6889. (London).

**Sale:** Eddystone 770 R VHF receiver, working order but requires re-alignment, otherwise excellent condition, with spare valves and manual, £35. Buyer collects. (Surrey).—Box No. 5400, Short Wave Magazine Ltd., 55 Victoria Street, London SW1H-0HF.

**For Sale:** Heathkit HW-202 with 10 crystals including R5 and R7, manual and all fittings, £95 or offers. **Wanted:** Trio TR-2200 or similar; 2m. aerial and mast; cheap rotator; GDO; VHF wavemeter; 2m. linears, 10w. and 30-60w. Details and price please.—Sayers, G8IYK, 13 Hodgebower, Ironbridge, Telford, Salop.

**For Sale:** Liner-2 with pre-amp. low-band, £120 or near offer. Inoue IC-20, fitted three channels, £70. Eddystone 940 Rx, £90.—Johnston, G8FZF, QTHR. (Tel: 01-640 3618).

**Exchange:** New ½-in. 2-speed drill, socket set ½-in. drive, ring spanners, breast drill, open-ended keys, metal and wood braces, wood bits, metal bits, levels, set squares, cramps, files, 2-in. blade planes, screwdrivers, tenon saw, pliers, hammers, good vice. All nearly new, various other items, whole on approval. **For:** AR88LF or AR88D Rx, or similar.—Murray, 86 Sloan Street, Ayr, Ayrshire.

**Wanted:** To buy or hire, manuals for early R.A.F. electronic equipment including TR-9, TR-1133, TR-1196, AI, ASV and SBA. (Kent).—Box No. 5401, Short Wave Magazines Ltd., 55 Victoria Street, London SW1H-0HF.

## G. W. M. RADIO LTD.

All prices include VAT and post/cargo

**RADIO TELEPHONES.** Storno Viscount CQM.39.25 L/B FM with cable, box and mike, £15. Storno 10 watt 230v. AC with desk controller and cable, L/B FM, £20. For callers only. Murphy base stations AM L/B, £10. All less channel crystals. BC221 complete charts, no psu, £18.

**TRANSMITTER** P.A. units STC T4188, tunes 2:8 to 18 Mc/s. manual or 28v. motor drive 13" x 8" x 8". Pair CV2518 (4X150) 28v. blower cooled. Bases are NOT UHF type. Ideal basis for linear amplifier construction, £9.

**TRANSMITTERS** MARCONI HT55N, 70-100 Mc/s. QQVO-40 PA. 2 x 5B25M Mod. 19" rack built-in. Good quality, table top case and with 100-250v. AC power built-in. Clean, untested, and ideal for 4 metre use, £10. Carriage is costly, much cheaper for callers.

**RECEIVER.** Ex-Army No. A510 covers 2 to 10 megs. Sensitive 5 valve superhet—receives single sideband—output for low impedance headphones. Well built, small and versatile piece of equipment. Overall case measurements approx. 8½" by 3½" by 6½", chassis size 5½" by 3½" by 6". Power required: 1.5 volts L.T. and 90 volts H.T. Excellent clean condition, complete but untested, with details of connections. Only £6.00 post paid.

**DIODE RECTIFIERS.** 41 HF40, 400v, at 40a, 60p or 4 for £2.10. BYZ13, 800v, 20a, 70p or 4 for £2.50.

**REED RELAYS.** 4-pole normally open, 5v. DC coil as used in recent Electronic Keyer design, 16p each (plus 10p post for any number). Also reed inserts 1.85" overall (body length 1.1"), Diameter .14". Max. ratings 250v. DC and 500 mA. Gold clad normally open contacts, 60p per dot marking and a set, £14.50. A few used but good, £10.50. Two Burned Co-ax plugs on lead to fit, 70p.

**AERIAL INSULATORS,** EGG type. White china 1½", 6 for 55p. Pyrex 2½", 55p each.

**CALIBRATORS FREQUENCY CT432.** 110/250 AC, 12" x 6" x 7½". 100 kc/s, 1 Mc/s, 10 Mc/s outputs from integral crystals. Provision for external crystals in the range 10 kc/s to 10 Mc/s. 4 front panel bases suit most types. RF sources may be fed in and calibrated by beating against desired crystal. Audio output to headphone socket. In Ministry packing and as new, £14.50. A few used but good, £10.50. Two Burned Co-ax plugs on lead to fit, 70p.

Key operated mains switches by Crater. 16a 3 pole on/off panel mounting with two keys, £1. Meters 1 ma calibrated 0-50. Approx. 3" square, £1.60.

**WATTMETERS ABSORPTION AF No. 1.** Max. 6 watts at 2-5 ohms to 20K, £10.

All Receivers and Test Equipment are in working order at time of dispatch  
Carriage charges included are for England and Wales only  
Telephone 34897

Terms: Cash with orders.

Early closing Wednesday.

**40-42 PORTLAND ROAD, WORTHING, SUSSEX**

## NOT ENOUGH ROOM . . .

to list all the numerous lines in stock in these 1-page adverts, so I now have a new toy, a Duplicator which will print lists as fast as I can buy the paper! At the moment a 5-page list is available giving full details of most lines: Cables, Sets, Spares, Aerials, etc., yours free if you send a S.A.E., large type if possible, or just a stamp will do. A selection from the lists—

**PYE RANGERS.** Boot mounted Transistor PSU, the boot mount unit less valves, ideal spares or rebuilt, only £2, post £1. Transistor Inverter from above, 160v. & 260v. DC out, £1.50, post 45p. Tx section with Mod. from above, £75p, post 40p.

Rx from HB Ranger less valves, 30p, post 20p. Multicores cables from them with plug, 4-5 yds. long, 60p, post 20p. Control boxes for the above in stock.

**MURPHY 821.** High band sets, boot mount model, unit only less valves, £1.50, post 60p. Transistor dip on PSU for above, £1. Control unit with Cables, Speaker and Mic, £2.50, post 75p. Mics from above, £1.50, post 20p. Carriers for above and AM25 Vanguard sets, 50p each, post 25p any number.

**REYCO.** Stainless steel Mobile Aerials, complete, £3.00 each, post 30p for any number. ½ wave whip. Magnetic Bases for above, £11.00 p.p. 50 less whip; with whip £12.00, post 50. State frequency required **XTALS.** 8075, 8077, 8079, 8081, £1 each, p.p. 5p. My lists contain several hundred others, only 75p each. S.A.E. please. Ex-Police 20-way DEAC Battery Chargers, 18v. at 22 ma, original costs about £120, £8, carr. £2. (Similar ones in WW at £25!)

**MAINS ISOLATION TRANSFORMERS.** These are a good buy at £2.95 each. 240 in out, 375 watts, post 60p. Weights 10 lbs and well made.

Storno Viscount 455 IF Boards Transistor, New at £1.50. Ex equipment at 80p, post 15p with circuit. Spares from AM25 Vanguards. Toroidal inverter Transformer, 170/375v. at 160 ma, £1.40, post 40p.

**MOD. TRANSFORMERS.** From Vanguards, £1.10, p.p. 40p. **RTTY.** Only 4 CREED 85R printing reperferrators. As new at £10 each you must collect in heavy condition.

**CABLES.** I can't list them all but I have Coax, UR76, UR67, UR43, UR70, UR95, XC4001, Multicores, 4 core, 8 core, 20 core screened. Mains: 2 core, 3amp; 3 core 3 amp; 3 core, 5 amp.

**EQUIPMENT WIRES.** 50,000 main stock all at from 50p to 75p per 100m.

Twin Screen Mic wires and other types. All well below wholesale prices, i.e. UR 76 normally 16p per m, my price 5p per m. plus post.

**Northern England Agent . . .** Jim Bateson of 4 Brook Street, Chorley, Lancs., who is acting as the agent up in that part of the country will have some lines in stock, especially Cables and Rangers, so call on him evenings and week-ends only if you live near. Tel.: Chorley 3294.

**W. H. WESTLAKE**

Clawton, Holsworthy, Devon. Telephone: Holsworthy 253758

## MORSE MADE EASY BY THE RHYTHM METHOD!

**FACT NOT FICTION.** If you start **RIGHT** you will be reading amateur and commercial Morse within a month. (Normal progress to be expected.)

Using scientifically prepared 3-speed records you automatically learn to recognise the code **RHYTHM** without translating. You can't help it. It's as easy as learning a tune. 18-W.P.M. in 4 weeks guaranteed. For Complete Course 3 Records & Books send £4.95 including P.P.I. etc. (overseas £1 extra.)

For further details of course Ring 01-600 2896 or send 4p stamp for explanatory booklet to:—S. BENNETT, G3HSC (Box 14) 45 GREEN LANE, PURLEY, SURREY

**WALKIE-TALKIE** 14 valve 4 channel No. 88 ex-WD transmitter/receiver unit, £6.50, p/p 75p. Padded moving coil ex-WD headphones, £1.25, p/p 25p. **STEEL BOXES**, hinged clasped, ex-WD, 31" x 13½" x 2½", ideal security, £2, p/p 75p. A bargain. **HELMETS**, steel, ex-WD, unused, £1.25, p/p 37p. **MOBILE** 12 volt ex-WD transmitter/receiver type 89 AFV set, £13, carriage £1.40. **EYESHIELDS** anti gas goggles, 36 packet, £1.00, p/p 25p. **GRUNDIG** valued stenorette units, £4, p/p £1. **A BARGAIN** 16kV, ex-WD meters, 3½", £4.50, p/p 25p. No. 19 ex-WD power pack, £5.50, p/p 50p. **SALVAGE** telemeter including valves, tapes, speaker amplifier, etc. Vast value cartoned, new, A.C., £4.50, p/p 50p. **EARPHONES** ex-WD DLR, unused, £1, p/p 25p. **SALVAGE** No. 19, used, ex-WD transmitter/receiver chassis, £6.50, p/p £1.50. **TELEPHONE** hand sets, £1.25, p/p 25p. No. 19 control box, ex-WD, with press and buzzer, unused, £1.55, p/p 50p. Vast stock of ex-WD and factory surplus at

### SOUTHERN SURPLUS MERCHANTS LTD.

66/68 LONDON RD., KINGSTON-UPON-THAMES, SURREY

Callers welcome 9-6 Monday to Saturday

### G3ACQ offers:

FT 75 — FR40DX — QR666 — SW Bridges — Yaesu microphones. All of the **SOLID STATE MODULES RANGE**. Bantex whips — Rotors — Hygain aerials. XTAL CALIBRATORS — SW Bridges — Absorption wavemeters — Scopes — Meters — Trio Walkie Talkies — G.D.O.'s — J Beam — L.P.F. — Clocks — AND 60,000 Crystals, 75p each. S.A.E. please.

### S. MAY (Leicester) LTD.

12/14 CHURCH GATE, CITY CENTRE,  
LEICESTER, LE1 4AJ  
Telephone : 58662

## SPRING SALE

OF

# HONDA GENERATORS

For full details and **SALE PRICES WHICH INCLUDE FREE DELIVERY IN THE UNITED KINGDOM,**

Call, Write or Phone **GODALMING 23279**. (24 hr. Answering Service). Open Tues. - Sat. 10.30 - 1.30, 2.30 - 6.30.

**Ashley  
Dukes**

**FARNCOMBE STREET,  
FARNCOMBE,  
GODALMING,  
SURREY.**

**Going QRT:** For Sale: KW-2000E with AC/PSU and Shure 201 mic., K.W. low pass filter, KW-103 SWR/Powermeter, all in very good condition (transceiver recently serviced by K.W.), £225 or near offer. "Electronic Developments" Magnum-Two 2m. transverter, brand new, not used, £75; will sell with the transceiver plus all leads etc. for transverter connections for £290, or near offer. 18AVT/WB antenna, little used, £28. Liner-2 PSU, unused in original box, £13. Creed 7B teleprinter with stacks of paper, £5; Heathkit "Cantenna" 1kW. dummy load, £5. Brand new 8/8-ele 2m. antenna, £10. 6-ele 2m. antenna, £2.50. Pye C.A.T. general coverage receiver Type PM-128, 50 kHz-31 MHz in 8 ranges, with PSU, leads, speaker and handbook, all in very good condition, £75. Home-built 2m. pre-amplifier, £1. "G8ARV" 400 mW exciter Tx, £2. Lead-acid accumulator, 12v. (ideal Pye Vanguard or Cambridge PSU), £2. AM-25T handbook, 50p. Two-metre 5-ele cubical quad antenna, brand new, £8. 320 PA valve, new, £1.50. Muirhead valve-maintained Tuning Fork, Type D68-A (ex-R.A.E. Farnborough), £3. Free receiving station log book to any SWL who comes and collects it.—Phipps, G4DIC, 47 Dean Road West, Hinckley, Leics. (Tel: Hinckley 36811 weekends; Northampton 30857 evenings, Mon.-Fri.; Northampton 31595 daytime, Mon.-Fri., and Sat. mornings).

**Sell or Exchange:** Yaesu FT-200 with power supply and microphone, little used and as new, £190. Or **Exchange** for "Seavoice" marine VHF transceiver.—Davies, Torre Hill Cottage, Ivybridge, Devon.

**Sale:** Trio TL-911 linear, three hours use since new last September, £125.—Robinson, G2KF, QTHR. (Tel: 072-681 2337).

**For Sale:** FT-101B with FV-101 VFO, as new, with extras, £350.—Holland, G3GHS, 01-399 6293. (Surrey).

**Selling:** Eddystone EC-10 Mk.II general coverage receiver, with Type 924 AC/PSU, in excellent condition, £70.—McRobie, Burley Cottage, Upper Ashe, Overton, Hants. (Tel: 025-674 421).

**Selling:** Viceroy Mk.IV transmitter, beautiful condition, £80. Dow-key coax relay, unused. Offers please?—Wyatt, G3BRW, 17 Harbour View Road, Dorset. (Tel: 0202-747756).

**Sale:** Trio 9R-59DS unmodified; Hamgear PM-IID preselector; S.G. Brown headphones; all in mint condition, £43.—Ring Wilson, Penrith (Cumbria) 3160 office hours.

**For Sale:** 32-S3 Collins "S"-Line Tx, one owner from new, direct from States, mint condition, no mods., with 516F-2 power supply and speaker, £375.—Scales, G3NRS, QTHR. (Tel: 0723-61238 day, 0723-60623 evenings).

**For Sale:** Microwave Modules two-metre converter, IF 2-4 MHz, six months old, hardly used, £10.—Ring Dallaway, Abingdon 29079.

**Read This:** Wanted VHF receiver, 50-150 MHz minimum coverage, e.g., old S.27 or similar. Will collect reasonable distance. Also wanted, references and handbooks on antennae.—Ring Payne, G3KCR, Crowborough 61782 evenings.

**Sale:** 9R-59DS Rx, boxed, in original condition and barely used, with manual, OA-2 and speaker, £40 plus carriage.—Derrick, 22 Spring Gardens, Rayleigh (762605), Essex.

**Selling:** PCR Rx with internal PSU and BFO, £12.50. Buyer collects or carriage extra. Auto-transformer, 100w., 0-200-215, 230, 245v. input, 0-10, 25, 115v. output, £2.50 inc. carriage UK.—Ring Hattersley, G3PJJN, Chesterfield 6040 after 6 p.m.

May Issue: To appear April 25, single copies at 40p post free will be despatched first class mail on receipt from printers. Orders by April 23, with remittance to: Circulation Dept., Short Wave Magazine Ltd., 55 Victoria Street, London, SW1H-0HF.

**Sale:** KW-2000E with AC/PSU and 110 Q-multiplier, year old, £290. KW-1000 linear, £120. All immaculate.—Caw, G4ALV, QTHR. (Tel: 01-460 3852).

**Wanted:** FT-101 Mk.1, II or B, must be fitted Top Band, electrical faults OK but must be mechanically sound and good external condition. Details and price please.—Johnston, G8FZF, QTHR. (Tel: 01-640 3618).

**A Chance to Own** the Rolls-Royce of mobile antennas: Swan de Luxe Model 55, covering 80 to 10 metres, remotely operated motor changes band on centre-loaded coil, meter unit mounted on dash of vehicle which reads band in use and relative output, standard ball mount included, £50 or near offer.—Scales, G3NRS, QTHR. (Tel: 0723-61238 day, 0723-60623 evenings).

**Sale:** 14-ele Parabeam, £8. TE-15 GDO, £10. K.W. LPF, 50-ohm, £2.—Wynes, G3TLV, QTHR. (Tel: Middlewich 2449).

**Offering:** Drake R4-C Rx, coverage 160-10m., first class condition, first reasonable offer secures.—Marshall, G4BJF, QTHR. (Tel: Loughborough 63324).

**Sale:** Transmitter, 80-10m., AM/CW, 40-50 watts, complete with PSU and modulator (at present working on 80-40-20m.), £15. All-transistor Tx, mobile, 160-80m., with modulator and mic., £7. Two-metre converter with two spare Nuvistors, no PSU, £4.—Callaghan, G3JMH, QTHR. (Tel: High Wycombe 34984).

**For Sale:** Eddystone 730/4 Rx in good condition, £80. R.107 in good order, £17. Collins TCS Rx in very good condition, with internal PSU, £18. Hartley Type 13A oscilloscope, dual trace, 5.5 MHz bandwidth, £25. Buyers inspect and collect.

**Wanted:** Airmec general coverage receiver.—Ellis, Rose and Crown, Brailsford (242), Derbys.

**Selling:** 14-ele 2m. Parabeam and 15-ft. pole, £7. SW-717 Rx, £20.—125 Armshead Road, Werrington, Stoke-on-Trent, Staffs.

**Wanted:** Teletype 32 or other modern page printer. Rascal RA-137 LF adaptor. Telegraph test set Type TDMS-70. LF adaptor for HRO-500. Collins R.389 or similar LF receiver. Details and price, please.—Passfield, 30 Greenleaf Close, Tulse Hill, London S.W.2. (Tel: 01-674 5825).

**Wanted:** Serviceable mains transformer for Model 339 Type 10 Cossor scope.—Aust, G8BRX, QTHR. (Waterlooville 52345).

**Offering:** Collins KWM-2 with Walters rejection-tuning; also 312B-5 console; late round-emblem series PM-2 portable power supply and MP-1 mobile power supply; CC-2 carrying case. In mint condition and has only very limited use (cost over £1,000). Sensible offers required.—Box No. 5403, Short Wave Magazine Ltd., 55 Victoria Street, London SW1H-0HF.

**For Sale:** Collins 51S-1, in mint condition, complete with 55G-1 low frequency tuner, and manuals, an exceptional receiver, £650.—Box No. 5404, Short Wave Magazine Ltd., 55 Victoria Street, London SW1H-0HF.

**For Sale:** Eddystone EC-10 Mk.1, with battery and mains PSU, excellent condition, £47.—House, 10 Leagh Close, Kenilworth (54556 after 6 p.m.), Warks.

**Sale:** FT-2FB 2-metre transceiver, eight months old and little used, nine channels fitted, J-Beam  $\frac{3}{8}$  whip, £110.—Powell, G8BPK, QTHR. (Tel: Aylesbury 630600).

**Wanted:** Heathkit SB-10U (or other) SSB converter. Details and price please.—Ring Churchley, 051-327 5989 (Wirral).

**G4DSG**

**G3HEO**

**D. P. HOBBS LTD.**

**YAESU FT101B.** 10-80 metre AC/DC Transceiver, 260 watts PEP. All modes—AM, CW, SSB ... .. £330-00

**YAESU FR101D RECEIVER.** 160 metre to 2 metre. SSB, AM, FM, CW with digital readout ... .. £330-00

**YAESU FT220.** 144-146 MHz. Transceiver. SSB, CW, FM. 10 watts Rms. Mains and 12 volt. Complete with microphone £264-00

**INOUE IC22 TRANSCEIVER.** Two metre, 22 channel mobile (3 channels supplied) ... .. £109-26  
(Extra crystals for above £4-00)

**INOUE IC255 TRANSCEIVER.** 80 channel. Pretuned. Max. freq. dev. +5 kHz with dynamic mic. ... .. £195-00

**MICROWAVE MODULES PRODUCTS :**  
2 metre Converters 1F's 2-4, 4-6, 28-30 MHz ... .. £15-20  
2 metre Converters 28-30 MHz IF with 116 MHz Lo. output for transverter ... .. £16-30  
70 Cms. Converters 1F 28-30 or 144-146 MHz ... .. £18-10  
2 metre Low Noise Preamp with 2 isolated outputs ... .. £9-00  
70 cms. Triplers. 2 metres in 70 cms. out. max. input 20 watts. Giving 12 watts out. ... .. £17-50

**ELECTROLYTICS** —Can type. Brand new :—  
1000 µF-100v. ... .. 25p  
32 µF-450v. ... .. 15p  
100 µF-60 µF-350v. ... .. 25p  
200 µF-200 µF-275v. ... .. 25p  
50 µF-50 µF-450v. ... .. 30p  
100 µF-60 µF-450v. ... .. 30p

**DENCO COILS** — CHASSIS — DIE-CAST BOXES. Hosts of components always in stock.

ALL GOODS CARRIAGE FREE

Add 8% for VAT. Part exchanges welcome. Barclay Card or Access.

11 KING STREET LUTON, BEDS.

Telephone : 20907

**C & C ELECTRONICS**

**MAIL ORDER CRYSTALS**

**NEW LOW SPRING PRICES**

Fundamental crystals 50ppm (0-60 C) or 30ppm (ambient), 4-21 MHz in HC6/U, HC18/U, HC25/U ... .. £2-97  
Overtone crystals 50ppm (0-60 C) or 30ppm (ambient), 21-105 MHz in HC6/U, HC18/U, HC25/U ... .. £2-97  
Normal delivery time within 4 weeks

**TX CRYSTALS (MHz)**

70-260 MHz	8-7825	
145-000 MHz	4-0277	8-0555
145-125 MHz R5	4-0312	8-0625
145-150 MHz R6	4-0319	8-0638
145-175 MHz R7	4-0326	8-0652
145-500 MHz S20	4-0416	8-0833
145-525 MHz S21	4-0423	8-0847
145-550 MHz S22	4-0430	8-0861
145-575 MHz S23	4-0437	8-0875
433-200 MHz	8-0222	

**RX CRYSTALS (MHz)**

70-260 MHz	29-7800	
145-000 MHz	44-7666	10-3246
145-125/145-725 MHz R5	44-8083/45-0083	10-3764
145-150/145-750 MHz R6	44-8166/45-0166	10-3782
145-175/145-775 MHz R7	44-825/45-0250	10-3800
145-500 MHz S20	44-9333	10-3603
145-525 MHz S21	44-9416	10-3621
145-550 MHz S22	44-9500	10-3639
145-575 MHz S23	44-9583	10-3657

All the above crystals are in HC6/U PRICE £2-00

10 MHz crystals suitable for Storno Viscount

**CONVERTER CRYSTALS IN HC18/U**

144/28 38-6666 MHz 144/4 70-0000 MHz 432/28 101-0000 MHz  
PRICE £2-86

All prices now include VAT and postage. 10% discount on orders of 5 or more crystals. Crystals supplied to any specification for PMR marine or military use, etc. State equipment/specification when enquiring. Please send s.a.e. with all enquiries. Rapid delivery service is available; information supplied on request.

**C & C ELECTRONICS**

(Dept. F) 10 WEST PARK, LONDON SE9 4RQ

## ESSENTIAL BOOKS

### HOW TO MAKE 2M & 4M CONVERTERS FOR AMATEUR USE

Fully comprehensive. Contains circuits, lay-outs, component lists, diagrams and full instructional notes. Price 60p p & p 15p.

### THE MOBILE RADIO-TELEPHONE EQUIPMENT HANDBOOK

A comprehensive handbook containing circuits, data and illustrations plus some valuable modification details for commercial radio-telephone equipment. The book is at present being printed and will be available this month after many delays. Price £6.25 which includes 50p p. & p.



### HOW TO MAKE WALKIE-TALKIES FOR LICENSED OPERATION, 40p, p & p 15p.

### THE GOVERNMENT SURPLUS WIRELESS EQUIPMENT HANDBOOK

Gives circuits, data and illustrations plus valuable information for British/USA receivers, transmitters, trans/receivers. With modifications to sets and test equipment. Latest impression £4, including postage.

### DIRECTORY OF GOVERNMENT SURPLUS WIRELESS EQUIPMENT DEALERS

Gives details of surplus wireless equipment stores and dealers including addresses, plus equipment and spares that they are likely to have available. A valuable book only 50p, p. & p. 15p.

### POWER SUPPLIES FOR ELECTRONIC EQUIPMENT

J. R. Nowicki. Published recently in two volumes. A comprehensive treatment of all types of power supplies. Vol. 1 deals with rectification, inverters and converters using silicon diodes, transistors etc. Vol. 2 gives a detailed account of stabilising circuits and step by step improvements are brought about by adding a circuit component at a time until more complex arrangements are achieved. Includes details of switched power supplies, thyristor inverters, and an introduction to static and sine wave inverters. Published at £4.50 per volume. SPECIAL OFFER—the 2-volume set for £4 post free.

### INTERNATIONAL DICTIONARY OF SEMICONDUCTORS

In seven languages. This excellent electronics dictionary is the result of an intensive collaboration between scientists and technologists. In two volumes are contained 1,373 pages. Although published at £16, we are pleased to make a special offer of this important reference work to readers at £6.50 per set. Car. 50p. The volumes are in a leather-styled finish and must have cost over £10 to print.

### BOOKS FOR SHORT WAVE LISTENERS HOW TO LISTEN TO THE WORLD

An indispensable aid to Short Wave Listening, £1.90, p & p 15p.

### CONFIDENTIAL FREQUENCY LIST HANDBOOK

Takes the wraps off and reveals for the first time the many hush-hush secrets regarding frequencies used by military organisations, The C.I.A., Coastguards, Spy Stations Aeronautical voice networks and many others too hot to mention. £2, p. & p. 25p.

### RECEPTION REPORTING FORMS

100 for £1, post free. 200 for £1.75. 500 for £4.

### WORLD RADIO & T.V. HANDBOOK. 28th edition.

£3, post free.

### SHORT WAVE VOICES OF THE WORLD

Explains the How and Why of this unique hobby. £2, post free.

### SWL ADDRESS BOOK

A big book giving a country-by-country listing of stations. With up-dater. £1.75.

**THE BARGAIN BOOK GAZETTE.** Contains thousands of interesting new and out of print books at bargain prices. Subjects include all types of hobbies, collecting. 100! interests. Published regularly and sent free on request.

DEPT. S.W.

## GERALD MYERS

Publisher & Bookseller

138 CARDIGAN ROAD, HEADINGLY,

LEEDS 6

CALLERS WELCOME

**Sale:** Versatower, electric winch, new and unused, £40 or near offer. Wilson mono-beams, unused, 8-ele for 10m., 5-ele for 20m. one used but perfect, 6-ele for 15m. (cost over £300) bargain lot £200 or near offer. Seco antenna tester, like new, visual good/bad antenna reading etc. Brand new Eagle Electronics alarm system with warning bell, very effective, £25. Belden 8448 Ham-M cable, 19-yds., £3.50. Katsumi MC-701 speech compressor (cost £15), bargain £8. Various mobile antennae: Hustler, Master-Mobile, Webster Band-Spanner, Ham-M and indicator, good condition, £45. Grundig TK-55 tape recorder, perfect condition (cost £100), £25. National HRO-60 cabinet and fittings, £5. Plus carriage.—Box No. 5402, Short Wave Magazine Ltd., 55 Victoria Street, London SW1H-0HF.

**Selling:** AR88LF receiver, needs overhaul, fitted S-meter, with speaker and manual; new spares for it; mains transformer, gear-box, set of dials, large capacitor, £20 the lot. New set of valves for SX-28, with manual, £5. Long range adaptor and power supply for R.206 Mk.II receiver, £10.—Ring Billington, 01-656 9882 after 6 p.m.

**Can't Beat colour TV QRM,** so QRT sale: Immaculate Inoue IC-700 Rx, IC-700 Tx, with speaker/PSU, £130. Also Heathkit DX-60 Tx, £25. Buyers collect.—Stampton, G3ZDR, QTHR. (Tel: Gravesend 63284).

**Selling:** Lafayette KT-340 Rx, suitable for beginner, good condition, £10.—Davidson, 26 Raeburn Meadow, Selkirk, Scotland.

**Wanted:** Newly-licensed schoolboy of limited means requires two-metre converter, IF 28-30 MHz; also two-metre Tx, or 10-2m. transverter. Everything considered, but no junk please. **For Sale:** "Radionic" construction set, £10.—Calder, 36 Gartshore Crescent, Twechar, Kilsyth, Glasgow, G65 9SX.

**Wanted:** Morse recorder; also Hallicrafters VHF receiver in working order. Details and prices please. (London).—Box No. 5389, Short Wave Magazine Ltd., 55 Victoria Street, London SW1H-0HF.

**Wanted:** Collins 75S3-B spares: step-up/step-down transformer, Part No. 622-0250-00; capacitor, electrolytic triple section, 40 micro-farad, Part No. 183-1764-00; also 1N1492, Part No. 353-1661-00; and any other Collins spares.—Box No. 5405, Short Wave Magazine Ltd., 55 Victoria Street, London SW1H-0HF.

**Wanted:** Amateur to overhaul and bring HRO-5T into top performance; receiver in very good and clean condition. SWL will pay reasonable price. (Essex).—Box No. 5406, Short Wave Magazine Ltd., 55 Victoria Street, London SW1H-0HF.

**For Sale:** Asahi Tribander beam, £45. 14-ele 2m. Parabeam, £12. 10-ele 2m. Skybeam, £10. Europa transverter, £60. "DJ6ZZ" transverter £20 "GW3ZTH" 2m. transverter, 4CX250 PA, £15. "G3RHI" SS/TV monitor, £15. "G3LIV" SS/TV monitor, £20. Two B5F bases for 4-125, £10. Two 4CX250B's plus bases, UHF, £10. Two E.M.I. CCTV cameras; Pye Lynx P.O.A.; Medco LPF, £4.—Wilson, GM3KJF, QTHR. Tel: Annbank (0292-52) 580, Ayrshire.

**Sale:** KW-202 receiver, at £120. K.W. Antenna switch and five PL259 plugs, £4.—Ryan, 48 Forge Lane, Higham, Rochester, Kent, ME3 7AL.

**Selling:** Eddystone 830/7 Rx, with plinth speaker and Hamgear PM-11C preselector, mint condition, £340. Buyer inspects and collects. (London).—Box No. 5393, Short Wave Magazine Ltd., 55 Victoria Street, London SW1H-0HF.

## INTRODUCING THE EMU-VFO

This latest in the Emu-unit range is ideal for the Amateur wishing to incorporate a VFO in his 2 Metre Tx. It operates on 8 MHz with a sine wave output of approx. 2v. p/p into a low impedance for coupling via co-ax to the Tx. Tuning is by Varicap diode, and a suitable value potentiometer is supplied. A separate diode is used to FM the oscillator which will give ample deviation at 2 metres. For sending Morse, a fraction of a volt keyed to the audio input will provide FSK. This unit is housed in a plain die-cast box 114 x 64 x 30mm. which is then further enclosed in an extruded polystyrene box for thermal insulation. It is intended that the user mounts it in the position most suited to his own particular system. You will find that stability is adequate for most Amateur applications. Price inclusive, **£9.50.**

**EMUPRESSOR.** The low priced speech processor that gives a gain at low audio input levels and a loss at high levels, giving you a fairly constant output from the Mic. This can be effective in raising the average speech level, and correctly adjusted can prevent you overmodulating. Price only **£7.80.**

**EMUMARKER.** This compact Crystal calibrator will be found most useful in the Shack for a Band edge marker, or setting your Tx on a particular channel. Two versions available, with 1 MHz, 100 kHz, and 10 kHz, or **EMUMARKER "25"** with 25 kHz as the lowest output. This is ideal for finding repeater channels. Price **£9.50** either model.

**EMU FM-UNIT.** One of the easiest ways of converting your Rx to FM reception. It requires only one connection to the main Rx, contains its own audio and output stages, Squelch and an AFC output. Approx 1 watt of audio is available to a low Impedance speaker. Complete and housed in a two tone box, **£13.50** or P.C. version, **£11.50.**

**EMU-CALL.** A call sign generator employing TTL and transistors that is programmed to your own Call to give station identification. Output is from a small speaker or from a Jack to feed direct into your audio stages. This is a complete unit housed in a cabinet 97 x 180 x 75 mm. with built-in mains power supply, all ready to use. Delivery is approx. 3 weeks. Price **£28.50.**  
*Money back guarantee, write for details on any Unit to:—*

## I. N. CLINE (G3EMU)

15 KNIGHT AVENUE, CANTERBURY  
CT2 8PZ, KENT

# RSL Components

G3LWM

- Miniature toggle switches
- Connectors specially imported. Fit Icom, Yaesu and other equipments
- Panel meters from £1-30
- SWR Meters and power supplies
- Tone burst kits
- Logic probes
- Ex storno boards
- LED's from 12p
- 7 segment displays £1-25
- Noon indicators

AVAILABLE 2 Meter transmitter and receiver modules  
SOON 2 Meter hand portables

Send large SAE for data and prices

## RSL COMPONENTS

52 Silver Street, Stansted, Essex  
Tel: Bishop's Stortford 0279-81429

## THE HAMGEAR "75" PRESELECTOR

A preselector designed especially for people who need to improve their reception but do not wish to spend a great deal. We have watched the pennies all along the way and produced a real solid little workhorse with the following points:—

Complete coverage from 80 to 19 metres in one swing, calibrated in metrebands.

A two stage amplifier with an average gain of 25 dBs. Fet with Bipolar.

Large High "Q" coil for highest gain.

A listen thru switch standard with our other models.

Antenna input 80 ohms. R.F. gain control but no ATU section. Same case as all our units—"teak" engraved panel with bronze hammer finish.

Internal mains power supply transformer/silicon rectifier with indicator.

Supplied in 115, 220 or 230 volts input.

Priced at only **£12.00**, direct manufacturer prices.

Send for details of this and our complete range—stamp please.

All our U.K. postage is now included in the price and overseas postage is part paid by us; Europe only £1.00 and U.S.A. £2.50 airmail.

## HAMGEAR ELECTRONICS

2 CROMWELL ROAD, SPROWSTON  
NORWICH, NR7 8XH

## G3EKX S.S.B. PRODUCTS G3EKX

### ★ SPEEDY CRYSTALS ★

Large stock available by return post. Send a list of your needs and alternatives. We will reply by return if you enclose a S.A.E. All metal and glass types up to 111 MHz.

OSCILLOSCOPE. CT52 with leads. 240v.—A.C.	£24
MULTIRANGE METER. U437 ,100 microamp. sens. Complete ... ..	£10
160m. MOBILE. TX/RX. G3SFL/M, whip, mic, 12v. Trans. pack ... ..	£30
NEW SWR BRIDGE with 2 meters. Reflec. and pwr. ... ..	£7.50
PYE V.H.F. BASE STATION. Rack type only ...	£20
HALLICRAFTER SKY RIDER SX24-5 to 30MHZ	£24
B40 RECEIVER +55 to 30 MHz 240v. A/C 1/P.1 ...	£22
PHILIPS K526-05 26in. colour TV. .New in box, unused, but tested OK. £325.99 list.} Offered at ...	£251.00
★ Last item buyer collects and will exchange it for "ham" equipment. Any gear considered. RX-Tx's wanted.	

CARRIAGE AND SAFE PACKING EXTRA

PAIR MATCHED 6HF5, £6.60; 6146, £6.80; 6146B, £8.60. Add 40p P & P.

1 FRANCES STREET, TRURO,  
CORNWALL Telephone: 0872-862575

## WORLD RADIO/TV HANDBOOK 1975

The World's only complete reference guide to International Radio & Television Broadcasting Stations. It includes: Frequencies, time schedules, announcements, personnel, slogans, interval signals and much more besides of value to the listener.

Lists all International short-wave stations, including frequencies, for each country; foreign broadcasts, long and medium wave stations (AM broadcast Band), TV stations and domestic programmes. Long recognised as the established authority by broadcasters and listeners. It is the only publication that enables you to identify BC stations quickly and easily. Enables you to fill more pages in your log book on the SW BC bands and helps you add more BC-station QSL cards to your collection.

**£3.74**

(The above price includes postage and packing).

from:

**SHORT WAVE MAGAZINE**  
55 Victoria Street, London, SW1H 0HF

**NEW !!**

## RADIO AMATEUR HANDBOOK (ARRL 1975)

This HANDBOOK, the most widely used manual of communications theory, design, and construction, contains descriptions of the latest solid-state devices and their application. The construction projects included cover the entire field of Amateur Radio interest. Written in a no-nonsense style, the HANDBOOK appeals to beginners and advanced amateurs alike. This edition contains 700 pages, including index, and nearly 100 new illustrations and drawings. Priced at **£3.27**, also available in a hard-covered clothbound edition at **£4.18** (both post free).

Order from

Publications Dept.

**SHORT WAVE MAGAZINE LTD.**  
**55 VICTORIA STREET,**  
**LONDON, SW1H 0HF**

## CALL BOOK 1975

**NOW AVAILABLE  
FROM STOCK**

**DX LISTINGS    £5.64**

**U.S. (Only) ,,    £6.10**

*The above prices include postage and packing.*

(1974 Editions no longer available)

**Please order your copy early from:**

Publications Dept.,

**SHORT WAVE MAGAZINE**  
55 Victoria Street, London, SW1H 0HF  
01-222 5341

## PRACTICAL WIRELESS CIRCUITS

This book contains more than 50 different circuits, and makes a valuable addition to the bookshelves of anyone interested in building radio sets or equipment. Transistor receivers, 22 in all, range from an ultra-simple crystal diode circuit to a sophisticated 10-transistor communications receiver. Valve receivers cover MW, SW and FM.

There is a chapter on transmitters and transceivers, and another on transmitter and receiver circuits for model control equipment.

Transistor and valve amplifiers include pre-amplifier, PA and stereo.

Circuits for an extensive range of test gear cover everything from a simple transistor tester to a comprehensive multimeter.

The step-by-step instructions which accompany the first few simpler circuits enable the absolute beginner to gain enough experience with circuitry building to tackle the more complicated work.

192 pages

**£1.43 inc. post**

Order from:

Publications Dept.

**SHORT WAVE MAGAZINE LTD.**  
55 Victoria Street, London, SW1H 0HF

# Technical Books and Manuals

(ENGLISH AND AMERICAN)

## AERIAL INFORMATION

Aerial Handbook (Briggs)	95p
Antenna Handbook, Volume 1	£1-86
Antenna Round-Up, Volume 1	£1-57
Antenna Round-Up, Volume 2	£1-87
Beam Antenna Handbook	£2-17
Quad Antennae, 2nd Edition	O/S
Simple Low Cost Wire Antennas	£1-82
Vertical Beam and Triangle Antennas (E. M. Noll, "73")	£2-57
Dipole and Long-Wire Antennas (E. M. Noll, "73")	O/S
Antenna Handbook (ARRL), 13th Edition	O/S

## BOOKS FOR THE BEGINNER

Amateur Radio (Rayer)	£1-70
Beginners Guide to Radio	£1-22
Beginners Guide to Electronics	£2-10
Beginners Guide to Transistors	£1-96
Better Short Wave Reception, 3rd Edition	£1-90
Course in Radio Fundamentals	£1-23
Foundations of Wireless and Electronics	£3-44
Guide to Amateur Radio	93p
Ham Radio (A Beginners Guide) by R. H. Waring	O/S
How to Become a Radio Amateur	67p
Learning the RT Code	35p
Morse Code for the Radio Amateur	29p
Radio Amateur Examination Manual	97p
Simple Short Wave Receivers (Data)	97p
Understanding Amateur Radio	£1-49

## GENERAL

ABC of Electronics	£1-70
FM & Repeaters for the Radio Amateur	£1-72
ABC of FET's	£1-42
Easibinder (to hold 12 copies of "Short Wave Magazine" together)	£1-26
FET Principles Experiments and Projects	£2-27
Guide to Broadcasting Stations (17th Edition)	90p
Ham (Radio) Notebook	£1-78
110 Semi-Conductor Projects for the Home Con- structor (Iliffe)	£1-32
How to Listen to The World (8th Edition)	O/P
110 Integrated Circuit Projects for the Home Constructor (Soft Cover)	£1-35
Practical Transistor Theory	£1-62
Practical Wireless Circuits	£1-43
Prefix List of Countries	26p
Radio Engineers Pocket Book (Newnes) (N.E.)	O/S
Test Equipment for the Radio Amateur	£2-12
Telecommunications Pocket Book (T. L. Squires)	£1-40
World Radio & T.V. Handbook 1975 Edition	3-74
Dictionary of Telecommunications	£2-47

## HANDBOOK AND MANUALS

Amateur Radio DX Handbook	O/S
Electronic Circuit Handbook, Vol. 1	£1-52
Electronic Circuit Handbook, Vol. 2	£1-52
New RTTY Handbook	£1-92
Radio Amateur Handbook 1975 (ARRL)	£3-27
Radio Amateur Handbook 1975 (ARRL) Hard Cover	£4-18
Radio Amateur Operators Handbook	84p
Radio & Electronic Handbook	£1-32
RTTY A-Z (CQ Tech. Series)	£2-37
Surplus Conversion Handbook	O/S
Slow Scan Television Handbook	£2-14
Television Interference Manual (G3JGO)	92p
Advanced Communication Systems	£8-52

## USEFUL REFERENCE BOOKS

Amateur Radio Techniques, 5th Edition	£2-26
Care and Feeding of Power Grid Tubes (ELMAC)	£1-71
Engineers Pocket Book, 6th Edition	£1-57
UK Call Book 1975	£1-22
Hams' Interpreter	87p
Hints and Kinks, Vol. 8 (ARRL)	72p
Radio Amateur Examination Manual (N.E.)	97p
Radio Data Reference Book (3rd Edition)	£1-12
Radio Valve and Transistor Data (Iliffe) 9th Edition	£1-02
Service Valve and Semiconductor Equivalents	40p
Single Sideband for the Radio Amateur (ARRL)	O/S
Sun, Earth and Radio	£1-00
Transistor Pocket Book	£1-66
NBFM Manual	£1-07

## TRANSISTOR MANUALS

ABC of Transistors	£1-42
Field Effect Transistors (Mullard)	£2-07
Handbook of Transistor Circuits	£2-47
Transistor Audio & Radio Circuits (Mullard)	£2-07
Transistor Fundamentals: Basic Semi-Conductor Vol. III, and Circuit Principle, Vol. I	£2-04

## VHF PUBLICATIONS

VHF Handbook Wm. I. Orr	£2-67
VHF Manual (ARRL)	O/S
Amateur Radio Awards (RSGB)	£1-47
Questions and Answers on Radio and TV	92p
Integrated Circuit Pocket Book	£2-74
Teleprinter Handbook (RSGB)	£5-50

O/P (Out of print)

THE ABOVE PRICES INCLUDE POSTAGE AND PACKING

T. O/S (Temp. out of stock)

Many of these titles are American in origin

Available from

Publication Dept., 55 Victoria St., London SW1H 0HF - 01-222 5341

(Counter Service. 9.30-5.15. Mon. to Fri.)

(Nearest Station: St. James's Park)

(GIRO A/C. No. 547 6151)



# B. BAMBER ELECTRONICS

5 STATION ROAD · LITTLEPORT · CAMBS. · CB6 1QE

Tel.: Ely (0353) 860185 (Tuesday - Saturday)

CALLERS WELCOME BY APPOINTMENT

## ELECTROLYTIC CAPACITOR PACKS

4.7mfd at 6.3v., 5 for 25p; 22mfd at 6.3v., 5 for 30p; 100mfd at 6.3v., 5 for 35p; 220mfd at 6.3v., 5 for 40p; 330mfd at 6.3v., 5 for 40p; 470mfd at 6.3v., 5 for 45p; 3300mfd at 6.3v., 5 for 95p.  
1mfd at 10v., 10 for 25p; 33mfd at 10v., 5 for 30p; 100mfd at 10v., 5 for 40p; 220mfd at 10v., 5 for 40p; 330mfd at 10v., 5 for 45p; 470mfd at 10v., 5 for 60p; 3300mfd at 10v., 5 for 95p.  
33mfd at 16v., 5 for 35p; 330mfd at 16v., 5 for 60p; 1000mfd at 16v., 5 for 95p.  
33mfd at 25v., 5 for 40p; 47mfd at 25v., 5 for 40p; 100mfd at 25v., 5 for 45p; 220mfd at 25v., 5 for 50p; 330mfd at 25v., 5 for 75p; 470mfd at 25v., 5 for 95p; 1000mfd at 25v., 5 for 95p.  
3.3mfd at 35v., 6 for 30p; 10mfd at 35v., 5 for 40p; 33mfd at 35v., 5 for 40p; 47mfd at 35v., 5 for 45p; 100mfd at 35v., 5 for 60p; 220mfd at 35v., 5 for 75p; 330mfd at 35v., 5 for 95p.  
2.2mfd at 50v., 10 for 40p; 22mfd at 50v., 5 for 40p; 33mfd at 50v., 5 for 45p; 330mfd at 50v., 5 for 95p.  
64mfd at 64v., 5 for 65p; 1mfd at 100v., 10 for 25p; .0015mfd min disc ceramics, 20 for 30p; 390pf tantalum at 500v., 10 for 30p.

## HANDI-PACKS

TV PLUGS (metal type), 6 for 50p.  
TV SOCKETS (metal type), 5 for 50p.  
TV LINE CONNECTORS (back-to-back skt), 5 for 50p.  
TO3 TRANSISTOR INSULATOR SETS, 10 sets for 50p.  
MIXED ELECTROLYTICS, large bag, £1.00.  
PC BOARD WITHDRAWAL HANDLES, mixed cols., 8 for 50p.  
SOLDER, 20SWG, 60/40 alloy, approx., 9 yds. 25p.  
OA81 DIODES, 15 for 25p.  
OC200 TRANSISTORS, 6 for 50p.  
PERSEX COIL FORMERS, 1½in. x ½in. dia., 5 for 25p.  
TURRET TAGS, ½in. dia., 25p pack.  
ROTARY SWITCHES, min. 4 pole 2 way, 2 for 50p.

**SPERRY 7-SEGMENT P.G.D. DISPLAYS**, digit height 0.3in. red, with decimal points, 150v. to 200v. (nominal 180v.) operation. These are the high-volt industrial type and therefore brighter than normal displays. All brand new. AT THE BARGAIN PRICE OF 50p PER DIGIT. TYPE 332 (two digits in one mount) £1.00 each. TYPE 333 (three digits in one mount) £1.50 (Sorry, no single digit available). Note: these are less than a quantity of manufacturers recommended price).

**DRIVER ICs** for above displays, SPERRY DD700, (16-dil) 50p each (only sold with orders for displays).

**DATA** covering L.E.D. displays and DD700 driver I.C. 30p.

**HIGH QUALITY SPEAKERS**. 8½in. x 6in. elliptical, 2in. deep, 4 ohms, inverse magnet, rated up to 10 Watts, £1.50 each, or 2 for £2.75. (Quantity discount available.)

**MAGNETIC DEVICES PROGRAMMERS**, contain 9 micro-switches with 9 adjustable drums for period switching (needs slow motion motor to drive drum) many switching applications, £1.00 each.

**STUD RECTIFIERS**, BYX42/300R, 300V at 10A, 30p each or 4 for £1.00.

**TRANSISTOR HEATSINKS** to take 2 x TO18 transistors, screw-in clamps. Block size 1in. x ½in. x ½in. with holes for mounting, 3 for 50p.

**TWIN HEAVY DUTY CABLE**, PVC covered, 50/0-25mm., 15p per metre, or £10.20 per 100 metre reel.

## BARGAIN BOXES

**ELECTRONIC IGNITION FOR YOUR MOBILE!** Cut petrol costs by up to 15%. Instal Electronic Ignition in your car in minutes. Reduces petrol consumption, increases overall performance. Prolongs contact-breaker and spark-plug life. Makes starting so much easier. Each unit (British manufacture) tested and guaranteed for 2 years/50,000 miles. Important: state positive earth or Negative earth when ordering, £11.80 +VAT (94p). Post paid.

**VARIABLE STABILISED PSU** solid state, 240v. AC input, Output 0-24v. DC at 500mA + 32v. at 50mA (approx.). Size: 7½" x 4" x 2½" (voltage controlled by external 5k ohm pot). (Less 5k ohm pot), £5.00 each. 5k ohm pots, 3 turn, for above, 75p each.

**EDGEWISE METERS**, 50 microamp FSD, centre zero, but can be left hand zero'd, display area 1½in. x ½in., smart modern appearance, £1.50 each.

**HIGH GRADE ELECTROLYTICS**, 6800 mfd at 25v., with screw terminals, complete with capacitor clip for vertical mounting, 50p each, discount on quantity.

**PL259 PLUGS (PTFE)**. Brand new, 50p each, or 5 for £2.25. Reducers for above, 15p each.  
**SO239 SOCKETS (PTFE)**. Brand new (4 hole fixing type), 50p each or 5 for £2.25.

**PLESSEY ELECTROLYTICS**, 10,000 mfd at 63V, Size 115 x 51 mm. 75p each. (Quality discount available).

TERMS OF BUSINESS: CASH WITH ORDER, MINIMUM ORDER OF £1.00. ALL PRICES NOW INCLUDE POST & PACKING (UK ONLY)

EXPORT ENQUIRIES WELCOME  
PLEASE ENCLOSE STAMPED ADDRESSED ENVELOPE WITH ALL ENQUIRIES

PLEASE ADD 8% VAT

**TELEPHONE TYPE EARPIECE INSERT**, 50p. REEDS (for reed relays). Single-pole make, 5 for 30p.

**MULLARD TUBULAR CERAMIC TRIMMERS**, 1-18pf, 6 for 50p (as featured in Rad. Comm. Jan. page 25).

ICs, some coded, 14DIL type mixed, untested, 20 for 25p.

**IF CANS**, ½in. square, suitable for rewind, 6 for 30p.

**IF CANS**, ½in. x ½in. x 1in., suitable for rewind, 10 for 30p.

**SMALL NEONS**, 6 for 25p.  
24v. MIN. REED RELAYS, encapsulated single-pole make, 2 for 50p.

24v. 2-8 LAMPS, MES type, 6 for 20p.

**CHASSIS TAGS**, 25p pack.

**CABLE CLIPS** for nailing cable, 15p pack.  
**MINIATURE SLIDER SWITCHES**, 2 pole, 2 way, 5 for 50p.

**BSY95A TRANSISTORS**, 6 for 50p.

6.3v. 0.3A CAPLESS LAMPS, 10 for 25p.

**PNP AUDIO TYPE TO5 TRANSISTORS**, 12 for 25p.

**BLACK PLASTIC KNOBS**, ½in. dia., ½in. spindle, 4 for 50p.

**RING MAGNETS**, 7mm. outside dia., 20 for 50p.

**25-WAY ISEP PLUGS AND SOCKETS**, 40p set (1 plug + 1 skt.). Plugs and sockets sold separately at 25p each.

**CANNON right-angled plugs XLR LNR15**, 75p.

**DIN SKTS** 5 pin 70 deg., 4 for 50p.

**DIN SPEAKER SKTS**, 2-pin, 4 for 30p.

**STANDARD JACK PLUGS**, ½in., 4 for 50p.

**ANDREW 44AN FREE SKTS. (N-TYPE)** for FH4/50B or FH14/50B cable, £1.00 each.

**BULGIN ROUND FREE SKTS**, 3-pin, for mains input on test equipment, etc., 25p each.

**SO239 BACK TO BACK SOCKETS**, £1.25 each.

**BNC INSULATED SOCKETS** (single hole type), 65p each.

## VALVES

**QVQ03/10** (ex equipment), 75p each.

**2C39A** (ex equipment), £1.00 each.

**QVQ02/6** (ex equipment), £1.00 each.

**4CX250B** (ex equipment), £2.10 each.

**4X250B** (ex equipment), £1.50 each.

**DET-22** (ex equipment), 2 for £1.00.

**EF80** (new), £25p **EZ81** (new), 25p.

**ECC81** (new), 30p. **ECC83** (new), 30p.

## MAINS TRANSFORMERS

All 240v. input, voltages quoted approx. RMS  
(Please quote Type No. only when ordering)

**TYPE 10/2 10.0-10V at 2A**, £1.50.

**TYPE 125BS** approx. 125v at 30mA, 65p.

**TYPE 16/6**, 16v. at 6A, 45v. at 100mA, £4.00.

**TYPE 28/4**, 28v. at 4A, 125v. at 500mA, £4.00.

**TYPE 63/1**, 6.3v. at 1A, 65v. each, 2 for £1.50.

**TYPE 129**, 400v. at 20mA, 200v. at 10mA, 6.3v. at 500mA, £1.25.

**TYPE 12703**, 400v. at 10mA, 200v. at 5mA, 6.3v. at 400mA, £1.25.

**TYPE 70462**, 250-0-250v., 50-0-50v., 6.3v., £1.75.

**MAINS ISOLATING TRANSFORMER**, 375VA, tapped primary, 240v. output, new, £6.00.

**MAINS ISOLATING TRANSFORMER** (ex equip.), in metal cases, totally enclosed, tapped mains input, 110-240v. etc., output 240v. at 3A + 12v. at 0.5A, £11.00.

**AS ABOVE**, output 240v. at 12A + 12v. at 3A + 22v. at 2.5A, £27.50.

**RADIO SPARES 500-WATT AUTO TRANSFORMER**, 100/110/130/200/220/240/250v. tapped input and output, step up or step down facility, ex new equip., £6.00.

**NEW, TO5 SILICON PNP TRANSISTORS**, unmarked, untested, approx. 100 for £1.50.

**PRESSURE GAUGES**, brand new, 2½in. flange mounting, 3 types available, state which, 0-60, 0-100, 0-200 lbs./sq. in., £1.20 each.

**NEW MULLARD SCOPE TUBES**, DN7-78, 3in. face, complete with CRT base and mu-metal screen, £8.50 each.

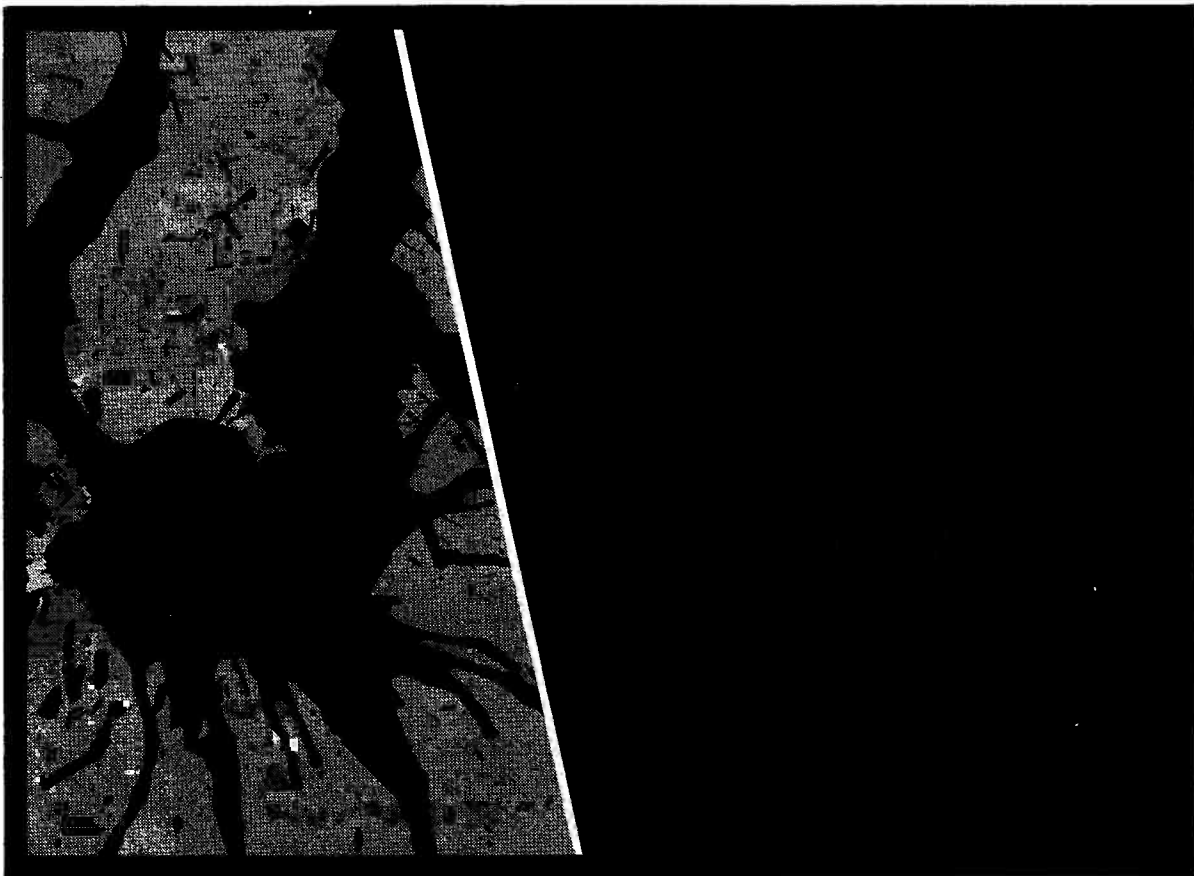

**SSB-ers:**

## increase talk power. cut "splatter"



**Our 444 base station microphone not only gives you increased talk power, but cuts "splatter" (and QRM complaints) to an absolute minimum! It has superbly tailored response, with sharp cutoffs below 300 and above 3,000 Hz and a rising response characteristic for maximum intelligibility. The 444's rugged, reliable Controlled Magnetic element has been proved in safety communications, and other tough professional communications applications. It delivers a clean signal to the transmitter at levels as high as crystal units! (And, unlike crystal and ceramic units, the element is totally immune to the effects of temperature and humidity.) The 444 also features an adjustable height stand that makes for comfortable "ragchewing" sessions, an optional-locking bar for push-to-talk or VOX operation, and a practically indestructible Armo-Dur® case. Write:**

Shure Electronics Limited  
Eccleston Road, Maidstone ME15 6AU  
Telephone: Maidstone (0622) 59881



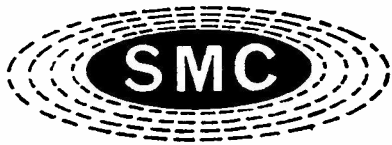

# SOUTH MIDLANDS

## 24 HOUR SECURICOR SERVICE FROM SMC

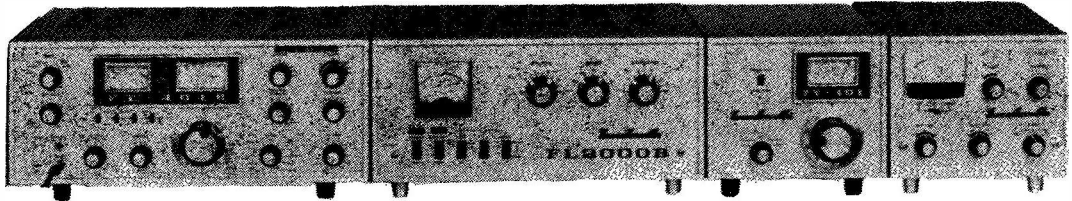

FT401B £307

FL2000B £195

£48

£80

The FT401B and its accessories are shown above, and provide an uncompromising approach to the home station. The FT401B itself runs 500 watts P.I.P., but when throttled back to drive the FL2000B and coupled with the FV401 external V.F.O. provides the base station with ultimate DX appeal.

The unit nestling on the end is the FTV650, a 6m. transverter which we can provide electrically modified for 70 MHz, 100W. P.I.P., 50W CW, 40W FM/AM, £80.00.

The FT620 features 1 kHz resolution VFO coverage across 50-54 MHz in 8 ranges, SSB (selectable) AM or CW (build your own FM modulator) 4 crystal controlled channels in each band segment, receiver offset clarifier, noise blanker, built in AC and 12v. DC power supplies, mic supplied, optional AM filter (£9) and crystal calibrator. The exceedingly low level of spurious emissions and the 50 MHz output makes this unit highly suitable for use as a drive source transverting to 4, 2 or 70 cms. and/or parametrically up converting to 70 or 23.

For use on 70 cms. we are pleased to announce the Microwave Modules transverter is now available for use with a 50 MHz I.F., £62.00.



FT62

50-52 MHz £175 50-54 MHz £180

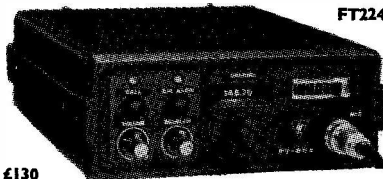

FT224

£130

The FT224 is an advanced Solid State transceiver featuring 10 watts output with a 24 channel flexibility (including priority channel) all in one complete package. The FT224 includes a built in tone burst for repeater actuation. Automatic high VSWR protection of the final transistor and reverse power line polarity protection are included. The wireless comes complete with built-in speaker, mobile mounting brackets and dynamic microphone.

S.M.C. models come fitted with 145.00, 145.50 and 145.55 MHz as standard.

FR101S  
£245FR101D  
£330FL101  
£265

Ex Stock

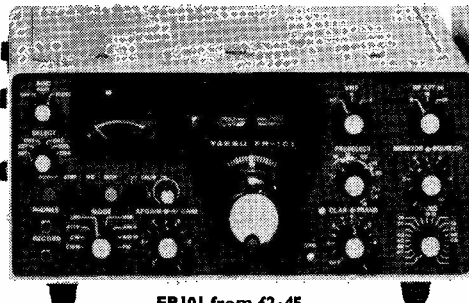

FR101 from £2.45



FL101 from £265

The FR-101 is an advanced receiver offering in the de luxe version, coverage from 1.5 MHz including all SW broadcast and HF amateur bands (23 in all) to 144 MHz. AM, FM, SSB CW are catered for, each with a separate crystal filter. Transceive operation with the FL or FT101.

The FL101 is the ideal companion to the FR101 thus forming a superb base station. Operation on 160 through 10m. using SSB, AM, CW or RSK is offered, with the added bonus of an option inbuilt RF speech processor being available at moderate cost.

STOCK / PRICE AND SECONDHAND LIST IN PRINT — SEND S.A.E.

**ACCESS  
BARCLAY  
HP FINANCE**

PLEASE NOTE THESE PRICES DO NOT INCLUDE VAT (8%)

Terms, cash with order, or card holders just phone in and we will despatch the same day. Immediate HP also available for credit card holders for amounts up to £150.

# COMMUNICATIONS LTD.



## YAESU MUSEN UK MAIN DISTRIBUTOR

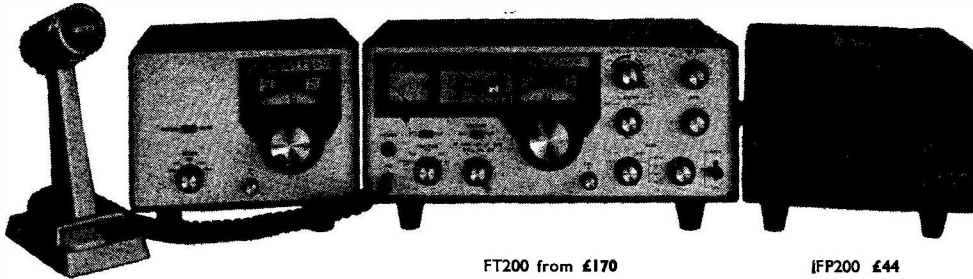

YD844  
FV200  
FT200  
FP200

All  
Ex Stock  
in Totton

FT200 from £170

FP200 £44

The FT200 is still without doubt one of the "best buys" available. Compare its features with similarly priced units. SPECIFICATION: 260w. p.e.p. 1/p SSB/CW; 75w. AM 1 kHz readout on all bands 3-5-4 28-5-29 MHz. (3 optional 10m. crystals available). Stability: 100 kHz 30 mins. after warm up. Sensitivity: 0-5uV 10dB S/S ±N. Selectivity: 2: kHz (6dB) 4 kHz (60dB). Solid state FET VFO with excellent linearity (like all Yaesu VFO's). 25/100 kHz Calibrator. VOX/PTT. Clarifier +5 kHz. Break in CW keying.

The newest of the Yaesu transceiver on offer the FT201. The FT201 features 80-10m. operation and the ability to run from the mains or a 12v. supply. It is constructed using plug-in modules as made famous in the FT-101. Of special interest to those contemplating using the 201 as a prime mover for VHF use, is the use of 9 MHz as the IF frequency and that full AM operation is possible (the optional AM filter being available). For the CW enthusiasts a 600 Hz filter is available with AGC characteristics to suit the mode. Write for full specifications.

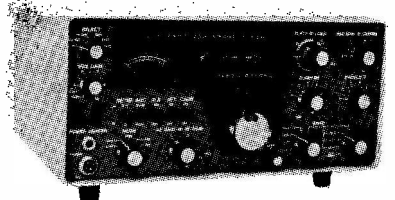

FT201 from £290

### YC355D

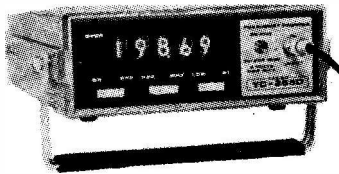

YC355 £104  
YC355D £125

The YC355 series counters are available in two models. The basic counts to 35 MHz and the "D" to 2000 or over. The YC355D outlines the advanced IC technics and the dual range system provides an accurate 8 digit read out using only the 5 tubes and of course minimum of cost with maximum performance. Built in AC and DC power supplies enable complete portability and double sided epoxy circuit boards ensures accurate operation for years to come.



FT101B £330

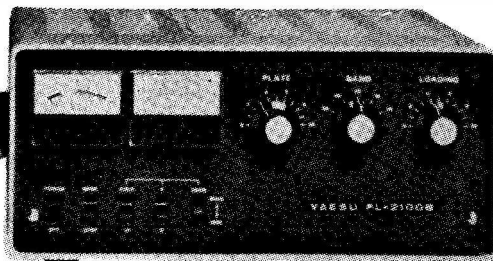

FL2100B £195

FT101B  
£330

FL2100B  
£195

Ex Stock  
in Totton

The FT-101B is except for driver and PA, fully solid state using reliable and serviceable "computer type" plug in modules. All that is needed for instant "on the air" operation from 160 through 10m. is either 12v. DC or 234v. AC and, of course, an antenna.

The FL2100B features operation 80 through to 10m. using two rugged 572B carbon plate tubes in class "B" grounded grid circuits with individually tuned input coils for each band, and Bifilar wound ferrite filament chokes.

SEE OVERLEAF FOR SELECTION OF MASTS, TOWERS, ANTENNAS, Etc.

## SOUTH MIDLANDS COMMUNICATIONS LTD.

Formerly trading as South Midlands Construction Ltd. and Western Electronics (U.K.) Ltd.  
OSBORNE ROAD, TOTTON,  
SOUTHAMPTON, SO4 4DN

Telephone: (04216) 4930 or 2785  
Cable: "Aerial Southampton"  
Telex: Chamcom 47388 Aerial SMC

AGENTS (Evenings):  
BRIAN KENNEDY, G3ZUL  
Droitwich (09057 4510)

IAN McKECHNIE, G8MDX  
Bridge of Allan 3201

SMC—A MEMBER OF THE ARRA  
Hours of Business: 9-5.30, 9-12.30 Sat.



# South Midlands

## CRYSTALS, FILTERS, PROCESSORS, LINEARS, READOUTS

### RF SPEECH PROCESSOR KPI2

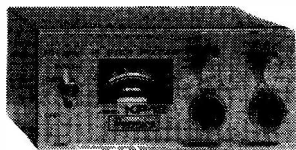

Audio to audio, via 107 MHz, mains powered illuminated meter, FT-101, FT2 plugs suitable all phone modes superb on FM.

EX STOCK IN TOTTON £44

### READOUT UNIT FOR FT-101, etc. DDI



Digital readout to  $\pm 100$ Hz for your FT-101 (B), FT401 (B), etc. 21 IC's 76 diodes provide a most worthwhile accessory.

AVAILABLE APRIL £110

### 144 MHz LINEARS RFL

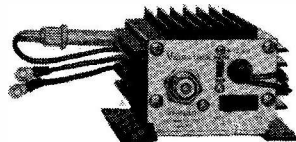

RF sensing, switchable drop out time SSB, AM, FM, CW, 12v. DC, 10W drive, 701-75W out, 801 100W out, 901 150W out.

701 £ , 801 £ , 901 £

### 9 MHz SSB FILTERS YF90/F/S

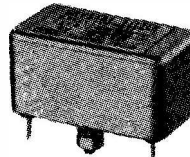

EX-STOCK at new low introductory price. 2.4 kHz, 6 pole, each individually supplied with  $\pm 6$  dB, 25 dB, 60dB bandwidths, ripple factor and insertion loss. With two crystals.

WITH U.S.B. and L.S.B. Crystals, £12.50 U.S.B. only, £11.50

### MICROWAVE MODULES (all 28-30 MHz I.F., others to order) P and P 30p.

70 MHz Converter ...	£15.20	144 MHz Converter ...	£15.20	144 MHz Pre amp 2 output ...	£9.00	432 MHz Transverter	£62.00
70 MHz Converter + L.O. output ...	£16.30	144 MHz Converter + L.O. output ...	£16.30	432 MHz Converter	£18.10	1296 MHz Converter	£24.00

## CRYSTALS NEW LOW PRICE (ALL POST PAID)

**FT2FB** (14 MHz Rx 18 MHz Tx)  
 144 (-15, -20, -30, -36, -48, -50, -60, -80)  
 145 (-05, -09, -20, -32, -40, -44, -51, -80, -84, -90)  
 All £3.30 pair, £1.80 single  
 Simplex 145 (-00, -500, -525, -550, -576, -600)  
 Duplex 145 (-100/700, -125/725, -150/750, -175/775)  
 All £3.50 pair, £2.00 single

**FT2F** (52 MHz Rx 6 MHz Tx)  
 144 (-15, -25, -36, -40, -48, -60, -70, -80, -96)  
 145 (-08, -09, -10, -20, -36, -40, -68, -80)  
 All £3.30 pair, £1.80 single  
 Simplex 145 (-00, -500, -525, -550, -575, -600)  
 Duplex 145 (-100/700, -125/735, -150/750, -175/775)  
 All £3.50 pair, £2.00 single

**STANDARD** 826 and 146  
 145 (.500, -.525, -.550, -.575, -.600, -.15/75)  
 All £3.30 pair no singles

**SPECIALS**  
 100 kHz £2.50  
 1 MHz £4.50

CRYSTALS TO ORDER—6/8 weeks delivery  
 Phone 04216 4930 for best prices.

### HY-GAIN THE BIGGEST RANGE FROM THE U.S.A. (Carriage paid)

Hy-Gain 18AVT/WB the great wide-band self supporting vertical (for 10-80 metres). Take the wide band, omni-directional performance of the famous 14AVQ, increase the bandwidth, add 80 metres use extra heavy duty construction and you have the 18AVT/WB. True  $\frac{1}{2}$  wave resonance on all bands, 52 ohm feed, BAND EDGE SVR of 2 : 1 or less, handles 1kW (AM), ultra low angle radiation and may be roof or ground mounted.

Hy Tower, 10-80m. Self supporting tower ... £132.00  
 18V, 10-80m. Vertical self supporting ... £15.50  
 12AVQ, 10-20m. Vertical self supporting ... £20.00  
 14AVQ, 10-40m. Vertical self supporting ... £29.50  
 LC80Q Loading coil for AVQ, 80m. ... £9.30  
 18AVT/WB 10-80m. Vertical ... £42.50  
 TH6DX 10-20m, 6 element beam ... £117.00

TH3 MK3 10-20m, 3 element beam ... £90.50  
 TH2 Mk. 3 10-20m, 3 element 600W ... £62.00  
 Hy Quad 10-20m, 2 element 40m ... £90.00  
 DB10-15A 10 and 15m, 3 element beam ... £69.00  
 DB24B, 3 element 20m, 2 element 40m. ... £129.00  
 402BA, 40m, 2 element ... £110.00  
 2048A 20m, 4 element beam ... £96.00  
 2038A 20m, 3 element beam ... £87.00

153BA 15m, 3 element beam ... £44.00  
 103BA 10m, 3 element beam ... £35.00  
 LA 1 Lighting arrester ... £17.50  
 LA 2 Lightning arrester ... £3.00  
 12RMQ Roof mounting kit ... £11.00  
 14RMQ Roof mounting kit ... £13.00  
 400 Rotor ... £139.00  
 BN86 Balun ... £9.50  
 TH3 Jnr. 10-20m, 3 element 600W ... £62.90

### B.M.C. TRAP DIPOLES (Carriage paid)

Trap dipole 10-80m. ... £16.85

Type HP (1kW pep) ... £18.75  
 Type P Portable ... £19.50

### SECONDHAND PRICE LIST

Yaesu FT501 and FP501 ... £340.00  
 FT401 and SP401 and YD844 ... £275.00  
 FR400 and CWV Fil. and FM Unit ... £140.00  
 FT75 ... £90.00  
 DC75 ... £15.00  
 FP 75 S/H ... £15.00  
 FV50C ... £25.00  
 FL2100 ... £155.00  
 Trio TS520 ... £275.00

JR310 ... £75.00  
 QR666... ... £100.00  
 Heathkit SB102 ... £255.00  
 OS2 ... £30.00  
 HW32 and (H.B.P.S.U.) ... £55.00  
 Eddystone 770R ... £105.00  
 ER14 ... £75.00  
 SR80A ... £30.00  
 National NCX5 and (p.s.u.) ... £160.00

HRO(M) with p.s.u. and 7 coil packs ... £30.00  
 HRC with p.s.u. and 9 coil packs ... £30.00  
 Inoue IC21 and VFO ... £135.00  
 Telford TC5 ... £22.00  
 Star SR200 ... £30.00  
 K.W. Viceroy ... £60.00

Bendix BC221 incorrect charts Ex W.D. ... £6.00  
 R216 ... £85.00  
 Racal RAC 417 ISB Adaptor RAC L.F. Adaptor RAC II Pre-Selector Units costing over £40.00, weight permitting delivery free of charge (usually by Securicor). Guaranteed 3 months (Labour). V.A.T. EXTRA at 8%

**ACCESS  
 BARCLAY  
 HP FINANCE**

PLEASE NOTE THESE PRICES DO NOT INCLUDE VAT (8%)

Terms, cash with order, or card holders just phone in and we will despatch the same day. Immediate HP also available for credit card holders for amounts up to £150.

# COMMUNICATIONS LTD.

ANTENNAS, TOWERS, MASTS, ROTATORS, COAX, Etc.

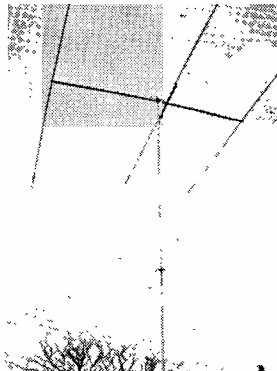
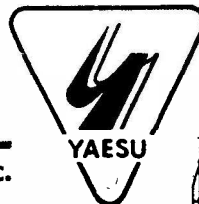

**VARSATOWERS** (Carriage paid, England and Wales)  
 Illustrated right. Tiltover Telescopic post mounted ex-stock. The tilting action allows ease of maintenance and changes of antennas. The relatively low weight eases installation problems.  
 From £172.25

**HAMTOWERS** (Carriage extra)  
 Galvanised lattice 10ft. sections 30ft. height with climbing steps on one face. From £90.00

**ALIMASTS** (Carriage paid, England and Wales)  
 A/Alloy Telescopic 1.5, 2, 3 metre sections from £11.60 for 6m, to £38.00 for 21m.

**THE COMPLETE RANGE OF JAYBEAM (AND MORE!) (Carriage extra)**

<b>OMNI-DIRECTIONAL</b>	HO/2M	Halo head only	—3dB 60 ohm	£1.85
	HM/2M	Halo with mast	—3dB 60 ohm	£2.20
	UGP/2M	Ground plane	0dB 60 ohm	£4.15
	XD/2M	Crossed dipoles	—3dB 60 ohms	£5.15
	XD/2M	Crossed dipoles	0dB 60 ohm	£5.75
<b>CIRCULAR</b>	5XY/2M	5 element crossed	7.8dB 50 or 75 ohm	£8.20
	8XY/2M	8 element crossed	10dB 50 or 75 ohm	£10.20
	10XY/2M	10 element crossed	13dB 50 or 75 ohm	£14.10
<b>4 METRES BEARING YAGIS</b>	4Y/4M	4 element	7dB 50 ohm	£6.80
	RZ100	Alignment bearing		£7.60
	5Y/2M	5 element Yagi	7.8dB 60 ohm	£4.30
	8Y/2M	8 element Yagi	10dB 60 ohm	£5.60
	10Y/2M	10 element long Yagi	13dB 50 or 75 ohm	£11.00
	14Y/2M	14 element long Yagi	14.5dB 50 or 75 ohm	£14.00
<b>SLOT FED</b>	D5/2M	5 over 5	10.3dB 50 or 75 ohm	£7.92
	D8/2M	8 over 8	12.6dB 50 or 75 ohm	£10.50
<b>PARABEAM 70 CENTIMETRES</b>	PBM14/2M	14 element parabeam	15.2dB 50 or 75 ohm	£16.90
	D8/70	8 over 8	12.6dB 50 ohm	£9.00
	PBM18/70	18 element parabeam	16.5dB 50 ohm	£10.50
	MBM46/70	46 element Multibeam	17.3dB 60 ohm	£12.10
	MBM68/70	68 element Multibeam		£16.10
	12XY/70	12 element crossed		£16.70

**ALL PHASING AND MATCHING HARNESSES AVAILABLE**

**TELOMASTS** (Illustrated above left). These galvanised steel telescopic guyed masts are most suitable for VHF up to medium sized beams.

They are easy to install and do not require special erection equipment.  
 Supplied either with or without rigging kits at the following reasonable prices:  
 30' ... £14.00 With rigging kit including turnbuckles, wire, etc. 30' ... £29.00 Carriage extra £1.50 England, £2.00 Scotland  
 40' ... £19.00 " " " " " " " " 40' ... £38.00  
 50' ... £24.00 " " " " " " " " 50' ...

**NEW LOOK!**

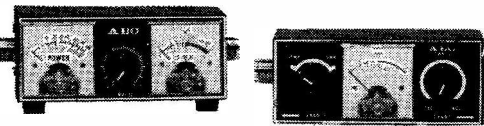

**NEW LOW PRICE SWR/POWER METERS**

SWR10 Reflectometer, single meter, accuracy quoted ±5% ... £6.30  
 SWR50 Calibrated for 50 and 75 ohm line, power meter (±15%) and SWR (±5%) ... £11.20

**CDE ROTATORS EX STOCK (IN TOTTON) FOR FAST DELIVERY**

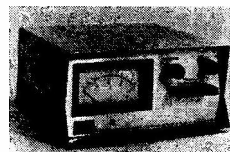

Carriage (B.R.S.) free. Securicar delivery 60p extra. All rotators supplied complete with appropriate control box and instructions.

- AR30 for Stereo and small VHF beams £25.00
- AR40 for Medium VHF/Small HF beams £30.00
- CD44 Arrays up to 2½ sq. ft. of wind area ... £60.00
- Ham II arrays up to 7½ sq. ft. of wind area ... £90.00

THE NEW CONTROL UNIT FOR THE CD44 AND HAM 2

Control Cable : 5 core for AR30/40 at 18p/m, 8 core for CD44/HII at 26p/m.

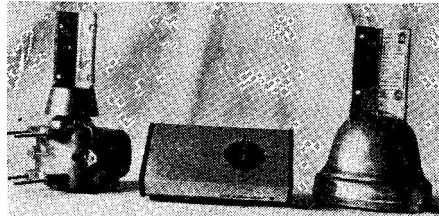

THE NEW SILENT CONTROL WITH AN AR30 AND AR40

**MOSLEY TRI BAND (10-15-20m.) BEAMS** (Carriage £1.75)  
 TA33 Jnr. E 3 ele. 200W TA32 Jnr. E 2 ele. 300W Mustang 3 ele. 2 kW PEP £60.00 Mustang 2 ele. 1 kW AM £48.00  
 RMS ... £45.00 AM ... £32.00

**BANTEX FIBREGLASS, STAINLESS STEEL VHF/UHF MOBILE ANTENNAS** (Carriage 75p)  
 B5 ½ wave 144 MHz ... £5.00 BSU BSU ½ wave 432 MHz £5.00 Magnetic Base Mount £7.50 Note: Deduct 50p from price of aerial if standard base not required.  
 BGA ½ wave 144 MHz £6.00 70½ 70½ wave 70 MHz £3.00 Trunk Lip Mount ... £5.10

**G WHIPS. The British Mobile HF Antennas Range** (Carriage 75p)  
 Tribander, 10, 15, 20 £12.30 LF40m., LF80m. or Flexiwhip 10m. with base £9.50 F15, F20, F40 or F160m. £4.20  
 Multimobile '71', 10, LF160m. ... £4.10 Basemounts only ... £1.85 Telescopic whips for coils £1.15  
 15, 20 ... £14.30 MM40, MM30 or MM160 £4.10

**RF CABLES** (Carriage up to 20m. 40p; over. 50p; less for lighter cables)  
 50 ohm R8BU/UR67 ... 33p/m 75 ohm UR39 ... 25p/m 75 ohm Flat twin ... 6p/m 75 ohm BICC 2378 ... 22p/m  
 75 ohm UR57 ... 33p/m 75 ohm Economy ... 10p/m 300 ohm Ribbon ... 6p/m 50 ohm UR43/UR76 ... 15p/m

**COAX (P and P extra)**  
 PL259 ... 42p PL259A ... 54p SO239 ... 33p BNC plugs ... 42p  
 Reducers ... 12p UHF Angle ... 90p VHF back to back ... 66p N plugs ... 83p

## SOUTH MIDLANDS COMMUNICATIONS LTD.

Formerly trading as South Midlands Construction Ltd. and Western Electronics (U.K.) Ltd.  
**OSBORNE ROAD, TOTTON, SOUTHAMPTON, SO4 4DN**  
 Telephone: (04216) 4930 or 2785  
 Cable: "Aerial Southampton"  
 Telex: Chamcom 47388 Aerial SMC

**AGENTS (Evenings):**  
**BRIAN KENNEDY, G3ZUL**  
 Droitwich (09057 4510)  
**IAN McKECHNIE, G6BDOX**  
 Bridge of Allan 3201  
**SMC—A MEMBER OF THE ARRA**  
 Hours of Business : 9.5-30, 9.12-30 Sat.

# AMATEUR ELECTRONICS UK

OFFICIALLY  
APPOINTED  
DISTRIBUTOR

for



**THE PERSONAL INSPECTION  
MR. S. HASEGAWA, PRESIDENT  
THE WARRANTY ON EVERY**

**The Incomparable Deluxe  
FT-101B**



This fine selection of YAESU HF Band Transceivers must commence with the ubiquitous FT101B—the definitive unit in the mobile/fixed field.

**Economical Mobile/Base Station  
FT-201**

Fresh on the scene is the FT201 which is setting new standards in its price range and has aroused much interest and some very flattering reports.



***GIVE AS GOOD AS YOU GET —***

**FULL DEMONSTRATION FACILITIES**

A COUPLE OF STAMPS (WE'LL PROVIDE THE ENVELOPE) WILL BRING YOU DETAILS OF ANY ITEM—PLEASE STATE SPECIFIC EQUIPMENT IN WHICH YOU ARE INTERESTED

● ALSO AVAILABLE  
FROM OUR  
ACCREDITED  
STOCKISTS

**RADIO SHACK LTD.**  
188 Broadhurst Gardens  
LONDON, NW6 3AY  
01-624 7174

**STEPHENS - JAMES LTD.**  
70 Priory Road  
Anfield  
LIVERPOOL, L4 2RZ  
051-263 7829

**508-514 ALUM ROCK ROAD  
BIRMINGHAM 8**

**021-327 1497  
6313**



**OF OUR SERVICE DEPARTMENT BY  
OF YAESU MUSEN UNDERWRITES  
YAESU ITEM SOLD BY US**

**High Power Base Station  
FT-40IB\***

Study these and the total YAESU story in the **FULL** glossy catalogue—See below.

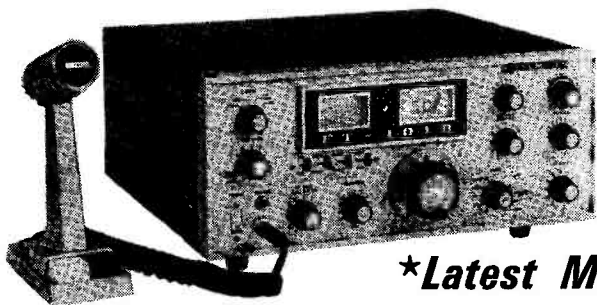

The very latest version of the famous FT401. Immensely popular with many operators for its exceptional specification and powerful signal.

***\*Latest Model!***

**Low Cost Base Station FT-200**

What can we say about the FT200? This has been a best-seller from the start—small wonder with such an exceptional specification at such a modest price.

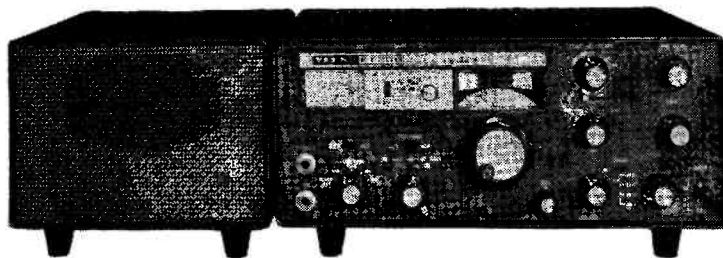

***TUNE UP A YAESU TRANSCEIVER!***

**PART EXCHANGES WELCOMED. EXCELLENT ON-THE-SPOT CREDIT TERMS.**  
IF YOU WOULD LIKE THE **FULL** YAESU MUSEN CATALOGUE EIGHTEEN PENCE IN STAMPS WILL BRING YOU THIS AND OUR CREDIT NOTE TO COVER

**J. & A. TWEEDY LTD.**  
79 Chatsworth Road  
Chesterfield  
DERBYSHIRE  
0246 34982  
AND WOODHALL SPA (LINGS.)  
52793

**TAURUS ELECTRICAL  
SERVICES**  
26-28 Nottingham Road  
LOUGHBOROUGH  
05093 5131

**THE AMATEUR  
RADIO SHOP, G4MH**  
13 Chapel Hill  
HUDDERSFIELD  
0484 20774



# LOWE ELECTRONICS



## TRIO TS520

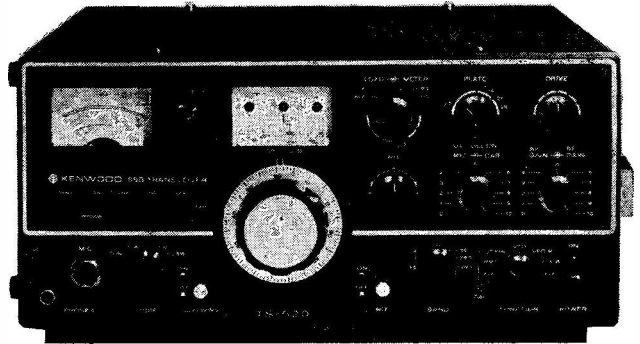

The TS520—latest in the new TRIO line of superior amateur radio equipment. Its styling and finish put all other rigs in the shade; and it is not just pretty—the front panel is a die casting giving unheard of strength and stability.

All semiconductor except for driver and PA, the TS520 is at home mobile, portable or fixed station thanks to built-in AC power supply and 12v. inverter. Blower cooled 6146's for long life and exceptional linearity.

\*TRIO exclusive. Built-in speech compression for that extra DX punch—without distortion, due to amplified ALC system.

Drop up a line for details. You'll be hearing them on the air from now on.

### FEATURES

R.I.T. ★ NOISE BLANKER ★ AMPLIFIED 2 SPEED AGC ★ 25 kHz CALIBRATOR ★ BLOWER COOLED PA ★ FIXED CHANNEL OPERATION ★ 4 FUNCTION METERING ★ AMPLIFIED ALC ★ BUILT IN SPEECH COMPRESSION ★ LED INDICATORS FOR FIX, VFO, RIT ★ LOW POWER TUNE UP FOR LONG PA LIFE ★ TRANSVERTER OUTPUTS (MATCHING TRANSVERTER ON THE WAY) ★ 12v. DC/240v. AC OPERATION ★ MATCHING SPEAKER AND VFO AVAILABLE ★

OBTAINABLE ONLY FROM LOWE ELECTRONICS PRICE £290 (VAT EXCL.)



## TRIO TS900

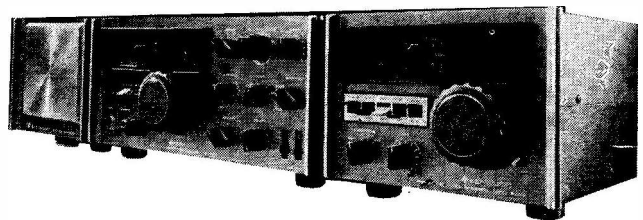

This is probably the finest amateur transceiver ever made. Professional design and construction make the TS900 a joy to own and use.

As QST (July 1973) said "This device has to be the pace-setter for the 1970's".

Full coverage 80-10; superb stability and selectivity; all mode operations including RTTY (crystal controlled RTTY shift built-in); all solid state except driver and PA; DC power supply and external VFO both available.

300W pep ★ All Modes ★ Separate USB/LSB Filters ★ 500Hz cw Filter Option ★ Four Function Metering ★ Two speed AGC ★ Noise Blanker ★ 0.1 Micro Volt Sensitivity (ARRL Measurements) ★ Blower cooled pa ★ Crystal controlled rtty generation ★ VOX ★ Break in cw ★ AC psu ★ DC psu ★

Write or phone for full specification and the reasons why the TS900 is the ultimate transceiver.

OBTAINABLE ONLY FROM LOWE ELECTRONICS PRICE £480 (VAT EXCL.)

# LOWE ELECTRONICS



## TRIO

### TR7010

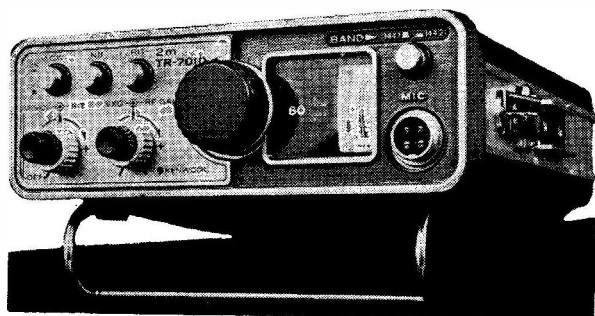

Following the worldwide success of the TS700, Trio have taken the TS700 basic design and packaged it for 2 metre SSB mobile use.

The TR7010 sets new standards in receiver sensitivity and low spurious emission on transmit. Operating CW and SSB from 144.1-144.3 MHz, the TR7010 covers CW, SSB and beacon activity. 40 5 kHz channels plus VXO and RIT provide continuous coverage. 8 extra channels can be used without retuning in the range 144-145 MHz by fitting auxiliary crystals.

Single conversion using an IF of 10.7 MHz with a superb crystal filter provides outstanding selectivity. Wide range amplified AGC and newly developed FET devices in RF amplifier and mixer stages allows maximum sensitivity to be used with freedom from overload due to adjacent signals.

Single conversion transmitter with new fully balanced mixer system generates a beautifully clean signal with crisp audio quality.

The first lucky owners are on two metres right now. Listen to the signal and make up your own mind. Why not send for full details of the all new TR7010 right now.

Price £165 (VAT exc.)



### TR7200G 2m Mobile Transceiver

22 Switch selected transmitting and receiving frequencies in the 2m. FM band between 144 MHz and 146 MHz, five of which are factory-equipped with TX and RX crystals. Illuminated channel indication.

Channels Fitted 145-50 Simplex 145-15/75 Duplex

145-525 Simplex 145-175/775 Duplex

145-55 Simplex

Price £125 (VAT exc.)

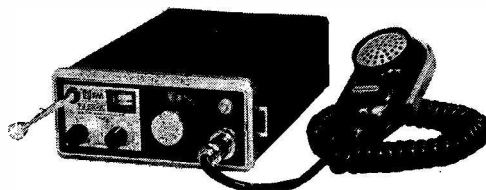

### TR2200G

The world's most popular 2 metre handy transceiver now comes complete with tuning fork controlled repeater access tone and facilities for 12 channels. With the advent of repeater operation in this country, it is now possible to work long distances with low power equipment and the sudden popularity of portable 2 metre equipment testifies to this fact. The TRIO TR2200G is a high performance transceiver with features not found in other rigs. Supplied with 3 channels fitted:

145-50 Simplex 145-55 Simplex 145-175/775 Duplex

Most other I.A.R.U. channels available.

Price £80 (VAT exc.)

#### HEAD OFFICE

119 Cavendish Road, Matlock, Derbyshire. Tel. 2817 or 2430 (9 a.m.-9 p.m.)  
Telex 377482 (any time)

#### BRANCH OFFICES

Goring Road, Steyning, Sussex. Tel. Steyning 814466  
Soho House, 362-4 Soho Road, Handsworth, Birmingham. Tel. 021-554 0708

#### AGENTS

Alan GW3YSA, 35 Pen-Y-Waun, Efail Isaf, Nr. Pontypridd. Tel. Newton Llantwit 3809  
John G3JYG, 16 Harvard Road, Ringmer, Lewes, Sussex. Tel. Ringmer 812071  
Sim GM3SAN, 19 Ellismuir Road, Baillieston, Nr. Glasgow. Tel. 041-771 0364

OPEN 9.00 — 5.30 TUESDAY TO SATURDAY INCLUSIVE

73 from BILL G3UBO/VE8DP, ALAN G3MME, JOHN G3PCY/5N2AAC, IAN G3ZYC

# LOWE ELECTRONICS



## TRIO

## STATION ACCESSORIES

### HAM CLOCK



Have you ever wondered why the amateurs in Hong Kong are not replying? Maybe it's because they're in bed and you forgot just how many hours time difference there is! The TRIO HC2 Ham Clock is a 24 hour battery powered (up to 1 year on a single HP2) clock which gives instant readout of the time anywhere in the world. Beautifully styled so that you won't know whether to keep it in the shack or out in the home, it is a real asset to the DX chaser. At only £11 (VAT exc.) it is incredibly good value.

### LOW PASS FILTER LF30

You know how difficult it has been in recent years to obtain a good low pass filter. Now the TRIO LF30 fills this need. The specification tells its own story.

POWER HANDLING	1 kW
CUT OFF FREQUENCY	30 MHz
STOP BAND ATTENUATION	90 dB
INSERTION LOSS	1.5 dB at 30 MHz
IMPEDANCE	50-100 ohms
CONNECTORS	SO239/PL259
DIMENSIONS (mm)	224 x 50 x 40

PRICE: £9 (VAT exc.)

### BAND PASS FILTER BPF2

This is a specially designed band pass filter centred on 145 MHz and is intended to be used between your 2 metre equipment and the antenna. Eliminate those out of band sprogies from your transverter in one easy move.

POWER HANDLING	50W continuous
PASS BAND	144-146 MHz
STOP BAND ATTENUATION	90 dB
INSERTION LOSS	1.5 dB
IMPEDANCE	50 ohms
CONNECTORS	SO239/PL259
DIMENSIONS (mm)	150 x 50 x 50

PRICE: £8 (VAT exc.)

### MC50 MICROPHONE

Matching microphone for all TRIO equipment. Contemporary styling and dual function construction allows use as hand or stand microphone. Dual impedance 600Ω/50kΩ and two coiled cords give complete versatility. Built in locking PTT switch. The TRIO MC50 is an attractive addition to any station and its performance is superb.

POLAR PATTERN	Cardioid
FREQUENCY RESPONSE	300 Hz-9 kHz
SENSITIVITY	-76dB at 600Ω -56 dB at 50 kΩ

(which really means that it will drive any transmitter that we've tried it on)

PRICE: £18 (VAT exc.)

### MC10 MICROPHONE

Superb hand microphone matching all Trio equipment. Press to talk or VOX operation. Supplied complete with coiled cord and 4-pin plug.

PRICE: £6.30 (VAT exc.)

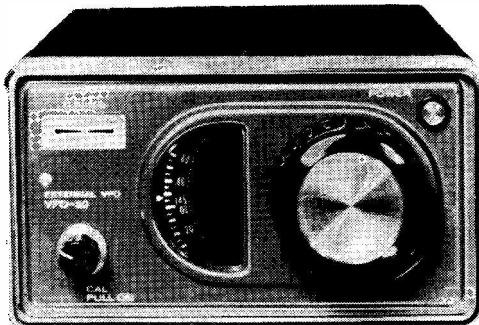

### VFO 30G

Matching VFO for TR7200G. Gives full band 144-146 MHz coverage on transmit and receive with built-in repeater shift. Centre zero tuning meter provided for accurate receiver tuning. Low frequency heterodyne type VFO for stable QSO's over long operating periods.

PRICE: £55 (VAT exc.)

# LOWE ELECTRONICS

We always have a large stock of excellent fully tested and guaranteed second hand equipment. The following list is a small selection of the items available at the time of compiling the list.

## RECEIVERS

Collins 51J3	... ..	Simply the best	... ..	£200
Yaesu FRsdx400	... ..	160 — 10 + 4m. 2m.	... ..	£135
Trio JR599 Custom Special	... ..		... ..	£132
Davco DR30	... ..	Almost pocket size but what performance	... ..	£100
Sommerkamp FR100B	... ..	Old Soldiers never die	... ..	£80
Eddystone EA12	... ..	Finest dial drive in the business	... ..	£120
Trio JR310	... ..	Why Oh why did they stop making this 1st class Rx.	... ..	£70
Yaesu FR50B	... ..	Same goes for this one	... ..	£65
Trio JR500	... ..		... ..	£45
Eddystone 888A	... ..	See above	... ..	£45
Trio 9R59DS	... ..	Long standing general coverage favourite	... ..	£40
Lafayette HA600...	... ..	Well, if you must	... ..	£40

## TRANSCEIVERS

Yaesu FT501D	... ..	At this price it's worth buying as a digital readout receiver !...	... ..	£295
KW2000B	... ..	If you must have 160 metres	... ..	£185
KW2000A	... ..	Older but some prefer it 'cos of the power supply	... ..	£165
Sommerkamp FT500	... ..	No linear needed with this rig. No shack heating either	... ..	£175
Ten-Tec Argonaut	... ..	O.K. so I was wrong. This rig really performs despite the domestic styling	... ..	£130
Ten-Tec 100W Linear	... ..	(yes, transistor)	... ..	£35
Liner 2	... ..	The rig that started it all	... ..	£110
Yaesu FT2F	... ..	Another example of the early model being preferred to it's successor	... ..	£65
Multi 2000	... ..	Good practice for a safe breaker	... ..	£170
TW Communicator 160	... ..	Would you believe AM ?	... ..	£25
Trio TR2200	... ..	Small enough to hide in your handbag ducky	... ..	£55
Heath HW32	... ..	The incomparable single band doorstop	... ..	£55
National NCX-5	... ..	Most under-rated rig on the market. Still top quality	... ..	£160

## SUNDRIES or if you prefer it **ODDS AND S...DS**

Europa	... ..	No, not the Lotus type	... ..	£55
Yaesu FP2	... ..	With Ni-cad. battery pack	... ..	£35
Spacemark SSM-I Monitor	... ..	As new	... ..	£120
Russian CI-16 Double Beam Scope	... ..	Pity about the red trace	... ..	£40

Above prices include VAT but not carriage. Securicor will bring your new toy to your door safely and quickly but it'll cost you £2.20.

QUOTE OF THE MONTH (When the man from the GPO inspects your log)

*"Where wert thou brother, those four days?  
There lives no record of a reply."*

Tennyson, supplied by Dick Winters of Melton Mowbray.

# EUROPA B

## 2 METRE, 4 METRE OR 6 METRE RECEIVE AND TRANSMIT CONVERTERS TO 28-30 MHz

Now in use in over 50 different countries! Exotic calls like A2, C31, 5W1, 9HI, 5BC, 2D8, KV7, KH6, TF, YB, VP8, VE8, etc.

Many of these people never use the receive converter—they have no local VHF activity and use their Europas exclusively for OSCAR work.



The Europa can be used with any normal H.F. equipment ★ Europa B features:

- ★ An aerial change over relay and SO239 antenna socket.
- ★ Adequate power for OSCAR work.
- ★ High transmit power. Up to 200W input, 50% efficiency.
- ★ Highest receiver sensitivity available—2dB N.F.
- ★ 28-30 MHz I.F. standard.
- ★ Cleanest output spectrum.
- ★ Extremely stable circuitry.
- ★ Well established and reliable design.
- ★ Additional crystals can be switched for extended frequency coverage.
- ★ Size: 9in. x 4½in. front panel, 4½in. deep.

All the prices include VAT (8%) and British Isles delivery. We export goods daily, so this is no problem. We can give same day C.O.D. service (£50 limit). All our products carry a 12-month guarantee. H.P. a pleasure. If you have any doubts, ring or write for assistance. See you at Leeds and Drayton Manor rallies. Please do not hesitate to contact us if you think we can help. Paul, G3MXG.

- ★ Low price, £88.00 complete to plug into Yaesu/Sommerkamp equipment.
  - ★ £74.00 less valves (2 off QQVO3/10 and 1 off QQVO6/40A required).
- } ex stock

For use with 6.3V Yaesu equipment (FL400, FT401 etc.) you feed in 12.6V AC at 2 amp. into the control socket. A suitable transformer is £3.24, or in a case to match the Europa £6.37. All from stock.

★ NEW! We now have in stock a complete AC PSU for the Europa, Type CSP 10.

This supplies all the voltages to power the Europa or Europa B. It also contains a 50 Ohm adjustable dummy load power attenuator and change over relay to reduce the 10 metre output power to a suitable level for driving the Europa.

This makes the Europa B compatible with HF equipment without transverter output sockets with NO modifications.

Size: Same as the Europa B.

Price: £38.50, ex stock.

### EUROPA 70-70 CM TRANSMIT CONVERTER

Designed like our Europa B to provide sufficient power for Oscar working—70W input hybrid design valves for transmit—transistors for oscillator amplification. Size: 6in. x 6in. front panel, 12in. deep. Price £43.20.

Other items (please note prices include VAT). Atlas 180 transceivers in stock, £280.80. Part exchanges welcome. DC200, £37.50. Crystals: 15.5 MHz, HC6U, £2.00: 38.666 MHz, HC18U, £2.00.

## SOLID STATE MODULES

63 WOODHEAD ROAD, SOLID, LOCKWOOD  
HUDDERSFIELD, HD4 6ER

Telephone: 0484-23991

*Manufacturers of V.H.F. and U.H.F. Receive and Transmit Converters and Pre-amplifiers  
for the Amateur and Professional*

MEMBER OF THE A.R.R.A.

SEE OUR OTHER ADVERT ON PAGE 109

# STEPHENS-JAMES

LTD.

70 PRIORY ROAD, LIVERPOOL, L4 2RZ

Telephone: 051-263 7829

# G3LRB - G3MCN

THE NORTH WEST'S  
LEADING STOCKISTS OF AMATEUR  
RADIO EQUIPMENT

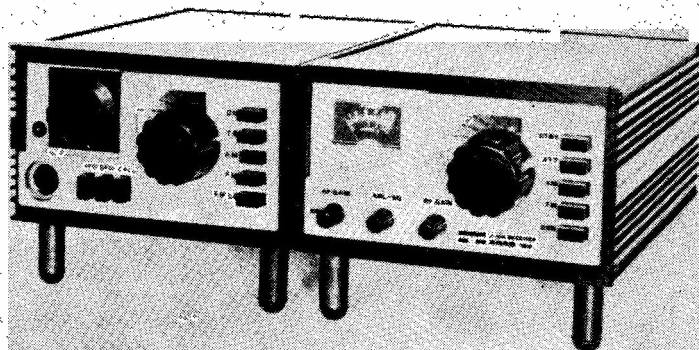

## ARAC 102 MOSFET RECEIVER

28 - 30 MHz  
144 - 146 MHz  
AM FM SSB

12v. DC operation. Built in speaker. 1uV for 10 dB S/N. Output 1.5 watt 8 ohm

PRICE £87-30

Delivery from stock  
Ideal for Oscar 7 Tracking

## ATAL 228

Solid State 8 watt AM/FM  
Transmitter

PRICE £123

Delivery April

<b>YAESU MUSEN</b>	<b>ANTENNA ROTATORS</b>	<b>HY-GAIN ANTENNA RANGE</b>
FT101B Transceiver ... .. £356-40	AR22R ... .. (Post 65p) £29-70	12AVQ 10-15-20m. Vertical ... .. £21-60
FT201 Transceiver ... .. £313-20	AR30 ... .. (Post 65p) £27-00	14AVT/WB 10 to 40m. Vertical ... .. £31-91
FTDX401 Transceiver ... .. £334-08	AR40 ... .. (Post 65p) £32-40	18AVT/WB 10 to 80m. Vertical ... .. £45-86
FR101D Receiver ... .. £356-40	CD44 ... .. (Post 75p) £64-80	BN86 Balun ... .. £10-26
FT200 Transceiver ... .. £232-20	Ham H ... .. (Post £1) £97-20	TH3MK/3 Tribander Beam ... .. £97-74
FL2100 Linear ... .. £205-20	Stolle Automatic 2010 ... .. (Post 65p) £33-48	
YC355 Frequency Counter ... .. £137-00	Stolle Multimatic ... .. (Post 65p) £37-80	<b>MICROWAVE MODULES (post free)</b>
<b>BELCON</b>	<b>BARLOW WADLEY</b>	2 and 4m. Converters (state I.F.) ... .. £16-42
Linear 2 Transceiver ... .. £156-00	XCR-30MK2 Solid state Receiver ... .. £125-00	MMCI44/20 LO Converter ... .. £17-60
100 Watt 2m. Linear ... .. £172-00	TR801 FM Tuner ... .. £17-15	432 MHz Converter ... .. £19-55
<b>CODAR</b>	<b>DRAKE</b>	432 Varactor Tripler ... .. £18-90
PR4 Preselectors ... .. (Post 25p) £11-00	TR4C Transceiver and AC PSU ... .. £349-92	144 MHz Dual output Pre-Amp ... .. £9-72
<b>MICROPHONES (post free)</b>	<b>SWAN</b>	<b>ATLAS</b>
Yaesu 844 Desk Microphones ... .. £16-12	700CX Transceiver ... .. £426-00	180 watt PEP Solid State Broad Band Transceiver, 20-40-80-160M, 12v. DC operation ... .. £280-00
Yaesu 846 Hand Microphone ... .. £6-30	300B Transceiver ... .. £307-00	
Shure 201 Hand Microphone ... .. £7-50	I200 Linear Amplifier ... .. £189-00	<b>G-WHIP</b>
Shure 444 Desk Microphone ... .. £16-00	MB80A Transceiver ... .. £184-40	Full range of the popular range of mobile antennas for 160 through to 10m. SAE for list and catalogue.
Shure 444T Desk Microphone ... .. £16-50	SS-200A Transceiver ... .. £538-00	<b>ELECTRONIC DEVELOPMENTS</b>
Electro Voice 729SR Desk Microphone ... .. £13-50	TB-4HA 4 Element Beam ... .. £135-00	2 and 4m. Transvertors ... .. £95-00
<b>JAYBEAM</b>	<b>SOLID STATE MODULES</b>	<b>SECOND-HAND EQUIPMENT</b>
Send large SAE for latest catalogue and price list of beams, clamps, masts, etc. 2 metres, 4 metres, 70 Cms.	PA3 Dual Mosfet Pre-amp ... .. £5-94	Magnum Speech Compressor for Drake TR or R4X ... .. £55-00
<b>KW ELECTRONICS</b>	Europa SSB Transvertors complete with valves £88-00 without valves ... .. £74-00	IC21XT Transceiver and VFO ... .. £165-00
KW 2000E Transceiver ... .. £373-68	<b>ACCESSORIES</b>	Racall RA17 Mk. 2 Receiver ... .. £325-00
KW202 Receiver ... .. £214-38	Planet 808 Speech Compressor ... .. £32-39	Eddystone 940 Receiver ... .. £140-00
KW204 Transmitter ... .. £273-78	Single Meter SWR Bridge ... .. (20p) £6-60	Yaesu FR50B Receiver ... .. £75-00
KW Linear Amplifier ... .. £198-18	Ceramic Dipole "T" Pieces ... .. 28p	Yaesu FR50B Rx., FLSOB Tx ... .. £150-00
KW 107 Matching Unit ... .. £74-31	PL259 Plugs 42p SO259 Sockets ... .. 14p	Eddystone EC10 ... .. £55-00
KW 109 Matching Unit ... .. £95-04	Cable Reducers ... .. 8p	Trio TS 510 Transceiver ... .. £195-00
KW 108 Monitorscope ... .. £20-05	300 ohm and 75 ohm twin feeder ... .. yd. £16p	KW2000 Transceiver ... .. £110-00
KW 160m. Antenna Match ... .. £24-41	UR67 40p UR233 ... .. £16p	Eddystone EC10 Mk. II ... .. £95-00
KW E-Z 80-10 metres ... .. £24-41	Omega Noise Bridge TE701 ... .. £14-85	Trio TX599 Transmitter ... .. £140-00
KW103 SWR/Power Meter ... .. £3-46	Omega Noise Bridge TE702 ... .. £22-06	
KW Balun ... .. £3-46	New Model. Antenna Tuning unit for SWL's will match any Antenna to any Receiver ... .. £13-50	
KW Antenna Switch ... .. £6-70	Morse Practice Oscillators ... .. £2-75	

Instant HP and Credit facilities available. Full after sales service. All our prices include VAT. We urgently need good second-hand equipment. Spot cash paid. Send details and price required. Collections and deliveries can be made in some areas. Postage extra. Delivery cost by arrangement on larger items. All items in stock despatched same day as order received.

Members of the Amateur Radio Retailers Association.

Shop Hours : 9.30 a.m. till 1 p.m.  
2.15 p.m. till 6 p.m.  
Half day Wednesday

S.A.E. is appreciated with all general enquiries. Three months guarantee on secondhand equipment. If you have equipment for sale and want good price, we will sell it for you on commission.

All prices include VAT



# Western

**UNITED KINGDOM DISTRIBUTOR  
OF THE WORLD'S FINEST RANGE OF AMATEUR  
RADIO EQUIPMENT  
BY**

## YAESU MUSEN



It's worth remembering that when you deal with WESTERN ELECTRONICS you have the best after-sales service in the country. We have the best equipped service department in the country in our trade and provide free collection and re-delivery on all warranty work. It's all part of our service!

**PRICE INCREASES ARE ON THE WAY FROM YAESU : BUY NOW !**

**IT'S REALLY RELIABLE and THE BEST BUY IN BRITAIN . . . the FT200**

YD844

FV200

FT200 £183.60 ± FP200 (£48.6)

PRICES inc. VAT

FOR

260w. p.e.p.  
10-80m.  
SSB-CW-AM  
1kHz READOUT  
CLARIFIER  
100 kHz  
CALIBRATOR

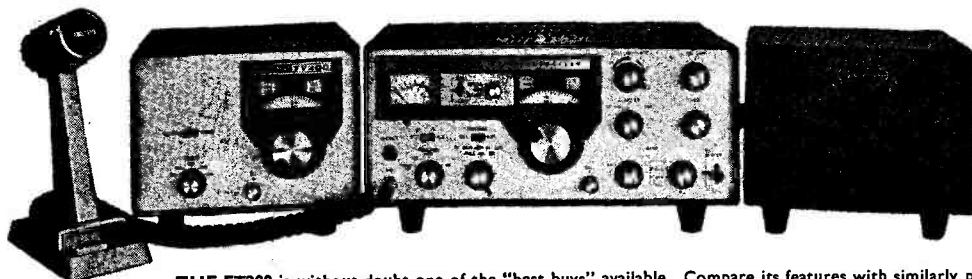

**THE FT200** is without doubt one of the "best buys" available. Compare its features with similarly priced units and kits. SPECIFICATION : 260w. p.e.p., i/p. SSB/CW; 75w. AM. 1 kHz readout on all bands 3.5-4, 7-7.5, 14-14.5, 21-21.5, 28.5-29 MHz. 3 optional crystals available for 28-28.5, 29-29.5-30 MHz. Stability : 100Hz 30 mins after warm-up. Sensitivity : 0.5µV 10dB/S + N. Selectivity : 2.3 kHz (6dB), 4 kHz (60dB). Solid state FET VFO with excellent linearity (like all YAESU VFO's), 25/100 Calibrator. VOX/PTT. Clarifier ± 5 kHz. Break-in CW keying. You will pay more for a kit with less power, only 5 kHz readout and no receiver incremental tuning (clarifier control). These prices only apply whilst current stocks last. 3 extra crystals fitted for full 10m. coverage, cost £8-10 inc. VAT.

**REMEMBER:** We have the experience and first introduced the "Yaesu" brand name to you in August 1970 by "Western Electronics," started by our managing director, Hal Perkins, G3NMH.

**SERVICE:** We do all labour FREE on warranty claims.

**SERVICE DEPARTMENT:** Our staff are trained! We have staff with experience in precision electrical measurements to Ministry EQD release and BS9000 requirements. Ours is no "amateur set-up!" We are prepared to undertake the test and calibration of test equipment itself.

**WARRANTY POLICY:** We maintain the manufacturer's full warranty and more besides.

**SPARES:** We carry an extensive range of Yaesu spares to ensure you get a good after-sales service.

**COLLECTION:** In the unlikely event of your having faulty equipment, all you have to do is phone/write us and we will collect by SECURICOR AT OUR EXPENSE and return the unit to you AT OUR EXPENSE.

**DELIVERY:** We deliver within 24 hours of receipt of order of items which are in stock. This is the fastest delivery service in the country and costs £1 per parcel only! 48 hr. service to Scotland and remote places. This service is limited to parcels less than 6ft. long and 50 lbs. weight.

**JUST PHONE YOUR ORDER IN!**

**NO LETTER WRITING — NO MONEY REQUIRED — JUST QUOTE YOUR ACCESS CARD OR BARCLAYCARD NUMBER AND  
WE DESPATCH THE GOODS!**

This service will be available to callers, mail and telephone customers; just another part of the finest service available to the U.K. Amateurs. We hope you'll give it a try! We'll despatch your order the same day if humanly possible by whatever means you wish. You may order anything which we sell by this high speed service, including used equipment, up to the limit of your Access or Barclaycard.

# Electronics (UK) Ltd

## THE VHF/UHF PAGE

### SSB/FM TRANSCEIVERS

**NEW! YAESU FT-221.** This is a new 2m. SSB/FM Transceiver to replace the FT-220 which is now sold out and no further supplies will be available. Please do not send to us for details yet as they are not off the "secret" list!

**FDK MULTI-2000.** We have new supplies of this fine unit pictured below. All units have 1750 Hz. tone burst built-in.

## the FDK Multi 2000 2m. SSB/FM/CW TRANSCEIVER

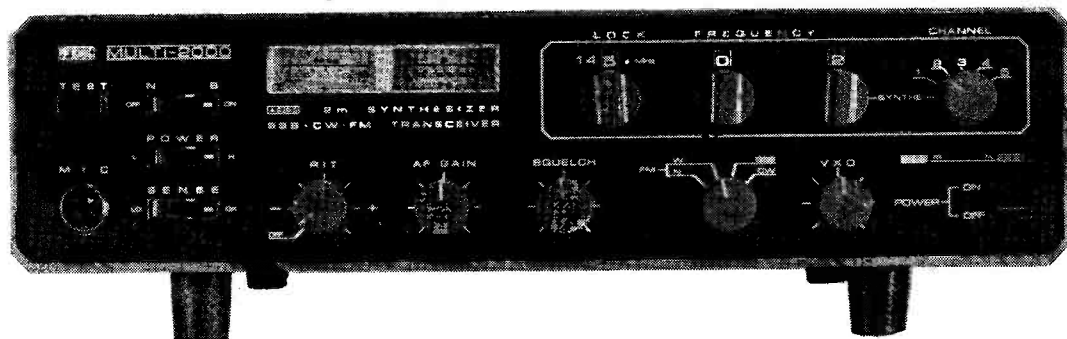

2m. SSB/FM and CW Synthesised 200 Ch. AC/DC. 10w o/p. (SAE for details please).

The **WESTERN ELECTRONICS MULTI-2000** has the following features

1. **DUPLEX OPERATION ON ALL CHANNELS**
2. **NARROW FM FILTERS FITTED AS STANDARD** (£291.6 inc. VAT).

So no matter on what frequency a repeater comes up, the Multi 2000 will tune it because don't forget that it has VXO control; i.e., you are not limited to 10 kHz steps, the VXO allows you to tune any frequency. There is a 9-pin socket on the rear to permit switching an external linear relay. All our models are marked "DUPLEX" instead of "I" on the channel switch shown in the above picture. **FREE DELIVERY BY SECURICOR.**

**BRAUN.** SEE600 Digital (the "Rolls Royce" unit!) £970.90 inc. VAT/Carriage.  
**SSB TRANSCEIVER.** Limer 2.144.1 - .34 MHz. £156.60 inc. VAT/Carriage.  
**FM TRANSCEIVERS.** YAESU and STANDARD.

**ANTENNAS.** BANTEX  
J BEAM  
NEWTRONICS

**TOWERS** VERSATOWER  
HAMTOWER  
TELETOWER

**MASTS** TELOMASTS  
ALIMASTS

**ROTORS** CDE

### THE OSKER SWR200 POWER METER

Features : Switchable for 52 or 75 ohm systems. Each instrument is individually calibrated. Four ranges : 0-2, 0-20, 0-200 and 0-2kW, 3-200 MHz. Excellent Styling.

Price : £22.68 inc. VAT.



**CATALOGUE.** We will be pleased to send you a copy of our COMMUNICATIONS EQUIPMENT catalogue (20p) or TOWERS, ANTENNAS and ROTORS catalogue (20p). No SAE required.

## Western Electronics (UK) Ltd

Agents : G3PRR, CHESHAM, BUCKS. (02405) 4143  
ALAN CAMERON, GM3OGJ, ALLOA (02592) 4653  
TOM CHESSLEY, G4CHP, NORWICH, SWAINSTHORPE 365  
DAVID LACEY, G8IYP, (available daytime also)  
SOLIHULL, WARKS., 021-744 4438  
**Hours of business:** 9.15 - 5.15, 9 - 12.30 (Saturdays)

1-3 WEST PARK ROAD, SOUTHAMPTON

TELEPHONE : SOUTHAMPTON 27464

CABLES : WESTRONICS, SOUTHAMPTON

TELEX : 47388 WESTRONICS





# Radio Shack Ltd ★

London's Amateur Radio  
Stockists

Just around the corner from West Hampstead Underground Station

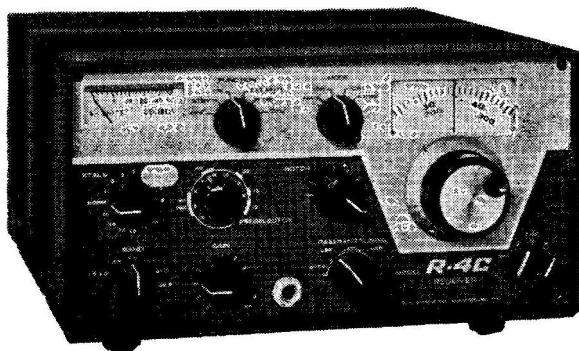

£279.72p  
Inc. VAT

## DRAKE ★ ★ ★ ★ SUPERIOR PERFORMANCE ★

### ★ LONG TERM RELIABILITY ★

### ★ MODEST COST ★

COMPARE QUALITY AND PRICE WITH ANY OTHER EQUIPMENT AND CONFIDENTLY BUY DRAKE  
PRICES INCLUDE VAT

#### RECEIVERS AND ACCESSORIES

R-4C Receiver, SSB, AM, SW, RTTY	... £279.72
FL250 Filter for R-4C	... £28.62
FL500 Filter for R-4C	... £28.62
FL1500 Filter for R-4C	... £28.62
FL4000 Filter for R-4C	... £28.62
FL6000 Filter for R-4C	... £28.62
4-NB Noise Blanker for R-4C	... £37.26
MS-4 Matching Speaker for R-4C	... £12.96
AL-4 Loop Antenna for SPR-4	... £16.20
SPR-4 Receiver. General purpose	... £291.60
Amateur Bands crystal kit for SPR-4	... £14.53
5-NB Noise Blanker for SPR-4	... £37.26
SCC-4 100 kHz calibrator for SPR-4	... £11.34
TA-4 Transceive adaptor for SPR-4	... £20.52
DC Power Cord for SPR-4	... £2.70
DSR-2 Digital Receiver	... £1,441.80

The above prices include VAT at 8%.  
Next-day delivery by Securicor costs £2.50 per major item.

#### HIRE PURCHASE A PLEASURE

WE ALSO STOCK THE T-4XC MATCHING TRANSMITTER, THE TR-4C TRANSCEIVER AND THE REST OF THE DRAKE LINE AND ACCESSORIES

S.A.E. WITH ENQUIRIES PLEASE

Carriage extra on all items

ALL PRICES INCLUDE VAT

**DRAKE — SALES — SERVICE**

SECURICOR ★ B.R.S. ★ ACCESS ★ BARCLAYCARD ★ TRICITY FINANCE

## RADIO SHACK LTD.

OPEN 5 DAYS 9 until 5 p.m. Sat. 9 until 1 p.m.  
CLOSED FOR LUNCH 1 p.m. until 2 p.m.

188 BROADHURST GARDENS  
LONDON, NW6 3AY

Just around the corner from West Hampstead Underground Station  
Telephone: 01-624 7174 Cables: Radio Shack, London, N.W.6.  
Giro Account No.: 588 7151

ADVERTISERS' INDEX

	Page
Amateur Electronics (G3FIK)	66, 67
Antenna and Electronic Consultancy Co. ...	114
Ashley Dukes (Honda) ...	116
Baginton Electronics ...	110
B. Bamber Electronics	<i>back cover</i>
J. Birkett ... ..	107
British National Radio School	108
C. & C. Electronics ...	117
I. N. Cline ... ..	119
Datong Electronics ...	108
Derwent Radio ... ..	112
G3HSC (Rhythm Morse Courses) ... ..	116
G3LLL Holdings Ltd. ...	114
G.W.M. Radio Ltd. ...	115
Hamgear Electronics ...	119
Heath (Gloucester) Ltd. ...	78
D. P. Hobbs Ltd. ... ..	117
K.W. Communications Ltd. <i>inside front cover</i>	
Lowe Electronics	68, 69, 70, 71
Marketing Services International	105
S. May (Leicester) Ltd. ...	116
Microwave Modules Ltd.	102
Mosley Electronics Ltd. ...	106
Gerald Myers ... ..	118
Northern Radio Societies Association ... ..	113
Partridge Electronics Ltd.	106
P.M. Electronic Services ...	114
Radio Shack Ltd. ... ..	76
RSL Components ... ..	119
R.T. & I. Electronics Ltd. ...	110
Shure Electronics Ltd. ...	61
Small Advertisements ...	114-118
Solid State Modules ...	72, 109
Southern Surplus Merchants	116
South Midland Communications Ltd. ... ..	62, 63, 64, 65
Spacemark Ltd. ... ..	103
S.S.B. Products ... ..	119
Stephens-James Ltd. ... ..	73
S.W.M. Publications	<i>inside back cover, 120</i>
Thanet Electronics ... ..	111
Telecommunications Inter- national Agency Ltd. ...	109
Telford Communications ...	105
T.M.P. Electronic Supplies	114
Waters & Stanton Electronics	104
Reg Ward & Co. Ltd. ...	113
Western Electronics Ltd. ...	74, 75
W. H. Westlake ... ..	115
Chas. H. Young Ltd. ... ..	103

# SHORT WAVE MAGAZINE

(GB3SWM)

Vol. XXXIII

APRIL, 1975

No. 378

## CONTENTS

	Page
<b>Editorial</b> ... ..	79
<b>Communication and DX News</b> , by E. P. Essery, G3KFE ...	80
<b>Mobile Rally Season—1975</b> ... ..	84
<b>QRP on Eighty</b> , by G. J. Bennett, B.Sc., Ph.D., G3DNF ...	85
<b>Transverter for Seventy Centimetres, Part II</b> , by A. H. Dormer, C.Eng., F.I.E.R.E., G3DAH ...	88
<b>Discussing the MJF CWF-2 CW Filter</b> ... ..	90
<b>Building the Venus SS/TV Monitor</b> , by P. Burnett, G4BLL ...	92
<b>VHF Bands</b> , by A. H. Dormer, G3DAH ... ..	94
<b>Counties of the British Isles</b> ... ..	97
<b>The Month with The Clubs—From Reports</b> ... ..	98
<b>New QTH's</b> ... ..	101

*Managing Editor:* AUSTIN FORSYTH, O.B.E. (G6FO/G3SWM)

*Advertising:* Charles Forsyth

*Published at 55 Victoria Street, London, SW1H-0HF, on the last Friday of the month, dated the month following. Telephone: 01-222 5341 & 5342*

**Annual Subscription:** Home: £4·20, 12 issues, post paid  
Overseas: £4·20 (\$10·00 U.S.), post free surface mail

**Editorial Address:** Short Wave Magazine, BUCKINGHAM, MK18 1RQ, England

**Prices shown in advertising in this issue do not necessarily constitute a contract and may be subject to change.**

### 'AUTHORS' MSS

*Articles submitted for Editorial consideration must be typed double-spaced with wide margins on one side only of quarto or foolscap sheets. Photographs should be lightly identified in pencil on the back with details on a separate sheet. All drawings and diagrams should also be shown separately, and tables of values prepared in accordance with our normal setting convention—see any issue. Payment is made for all material used, and it is a condition of acceptance that full copyright passes to the Short Wave Magazine, Ltd., on publication.*

© Short Wave Magazine Ltd.

# Complete the coupon and we'll send you our new catalogue. Completely free.



The new Heathkit catalogue is now out. Full as ever with exciting, new models. To make building a Heathkit even more interesting and satisfying.

And, naturally, being Heathkit, every kit is absolutely complete. Right down to the last nut and bolt. So you won't find yourself embarrassingly short of a vital component on a Saturday evening—when the shops are shut.

You'll also get a very easy to understand instruction manual that takes you step by step through the assembly.

Clip the coupon now and we'll send you your free copy to browse through.

With the world's largest range of electronic kits to choose from, there really is something for everyone.

Including our full range of test equipment, amateur radio gear, hi-fi equipment and many general interest kits.

So, when you receive your catalogue you should have hours of pleasant reading.

And, if you happen to be in London or Gloucester, call in and see us. The London Heathkit Centre is at 233 Tottenham Court Road. The Gloucester showroom is next to our factory in Bristol Road.

At either one you'll be able to see for yourself the one thing the catalogue can't show you.

Namely, how well a completed Heathkit performs.

Heath (Gloucester) Limited, Dept. SW-45, Bristol Road, Gloucester, GL2 6EE. Tel: Gloucester (0452) 29451.

A new oscilloscope from the Heathkit range. Marine direction finder with digital read-out. Solid-state grid dip meter.

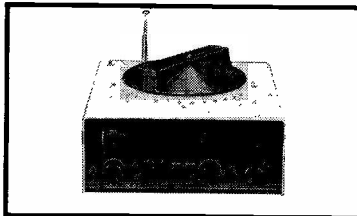
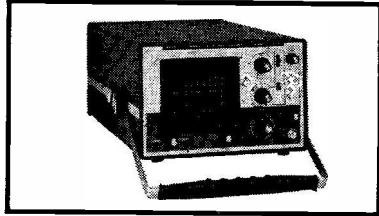

## The new Heathkit catalogue. Out now. FREE.

To: Heath (Gloucester) Limited, Dept. SW-45, Gloucester, GL2 6EE. Please send me my free Heathkit catalogue.

Name \_\_\_\_\_

Address \_\_\_\_\_

Postcode \_\_\_\_\_

Remember easy terms are available with the Heathkit Monthly Budget Plan.

HEATH  
Schlumberger

# The SHORT-WAVE Magazine

E D I T O R I A L

## ***Imposition***

Nobody glancing over this piece will need to be told that we now have to bear a considerable increase in postage charges. It is not just the 5½p/7p rates for letter-mail, which affect everyone.

What, then, is our particular problem? In the first place, mailing of the Magazine to each direct subscriber—several thousand of them—costs another 36p a year. Multiplying that out brings the increase for direct-subscriber postage alone to a substantial four-figure total—just like that. Then there are the parcel deliveries, to numerous retail and wholesale outlets in the newsagent category, through whom most of our circulation is achieved and for which, of course, there is no cover—and it is here that the percentage increases are much steeper.

Like many other publishers, we have in effect become unpaid tax collectors, because an increase in postage/parcel rates to bring the Post Office accounts into balance does amount to “taxation,” since the postal service is a Govt. monopoly and there is no alternative method of distribution.

Naturally, we are always looking for economies in every direction but there are limits beyond which costs can be pared no further if any sort of standard is to be maintained.

One necessary measure is that, to hold some degree of balance, with immediate effect the direct-subscriber rate will have to go to £4.20 for a year of 12 issues, post paid. Of course, all existing subscriptions will continue to be honoured at the rate already paid—but new subscriptions and renewals will have to be charged at £4.20.

We much regret having to take up space to make an announcement of this sort—but we think it right that readers should understand the circumstances that compel it.

And we might as well admit, here and now, that there will shortly have to be an increase in cover price.

*Austin Forsyth  
G6FO*

# COMMUNICATION and DX NEWS

*E. P. Essery, G3KFE*

PERHAPS the first thing this month is to refer back to the note on ZC4EJ, on p. 658, February. Just too late to catch the last CDXN, ZC4EJ himself rang up—he is G3LEJ at home—to point out that he is a very genuine station and that his QSL manager is in fact G3ZGG, not G3ZCC (who has been getting the cards) and additionally that when operating, he *always* spells out the call phonetically, realising that many people who work ZC4EJ do not easily speak English. This being the case, the cards that G3ZCC was getting were either due to QRM at the receiving end, or just plain bad writing; not, by any stretch of the imagination, piracy. In addition, the ZC4 Society's secretary, 5B4WR, wrote to say he knew ZC4EJ to be OK, and to suggest how to deal with the problem. The upshot of it all was that we wrote to G3ZCC asking him to pass on the cards to the right quarter, and copied it to G3ZGG and G3LEJ. What it boils down to is this: If you worked ZC4EJ and haven't had your card back, if you sent it to G3ZCC (or if your writing makes a G look like a C) then be well advised to send a duplicate card, either direct or through the Bureau. Thanks to 5B4WR, also to ZC4EJ/G3LEJ, for letting us know the real problem as soon as they realised what was up.

## Around The Bands

The sunspot count gets ever lower; but still the faithful press on, although the realms of super-DX offered by about every contributor a few years back are just not to be had. On the other hand a consolation is that your conductor understands the first sunspot of the new cycle has been recorded as appearing at solar latitude +37 degrees on November 15 last year—which is not saying we have yet hit bottom, merely that we are getting near it!

## Top Band

There is a dearth of reports all through this month, but we have a little to show and to talk about. G3KFE has been threatening to come back on the band with a QRP CW rig, but at this moment is a bit hampered by having just one rock on 1800 kHz dead, and the certain knowledge that *somewhere* around the place there are two at suitably juicy frequencies, but gone into hiding at the bottom of the junk-box.

G2BJY (Walsall) sent in quite a report about 160m. For all practical purposes he has cleaned out the counties and regions saving for Gwent, Clwyd, and Cleveland on the key, and is now going the rounds on SSB, the rig being his old home-built ten-metre Tx suitably modified. Then there will be the set to work on AM, and to that end, Geoff wants a Top Band AM contest laid on—*crikey!*

A newcomer to the game who is quite clearly enjoying himself on Top Band is G4DDG (Derby) who has a KW-2000B and describes the result as "broke but happy!"—we know the feeling. David has been mainly padding about on Top Band CW; not a lot of DX, he says, but plenty of nice natters. This sounds as though we have a *real* CW man to deal with—let's hope G4DDG can see fit to put an entry on to the Ladder in due course, but meantime, welcome aboard.

G4AYS (Moir) thoroughly enjoyed the chase with his crystal-controlled gnat-power device, although there has been quite a lot of QRM from other activity around his rock frequency, which G4AYS seems to make into an additional pleasure of the chase! Anyhow, although the gotaways predominated this time, he did manage to work G3UMJ for Northumberland, and the writer's old pal G3TLF up on Humber-side.

Questioning the OK30 prefix appearing on the band and putting up his ladders score is the main thing for G4BOH (Bury). These are in commemoration of thirty years since Czech liberation from Nazidom—how time flies!

G4CTR (Poole) has not been very active due to the onset of the dreaded A-levels, but since December Roger has been doing a bit whenever he can find the time, mainly on Twelthy with his FT-101B and a 132-footer; however, Top Band was not altogether neglected, and he managed to raise EI2BB, PAØRYS and GB3NEW. G4CTR is starting to build a slow-scan monitor at the moment and is looking for a 5FP7 tube for the beast, so far without much luck.

GD4BEG (Sulby, I.o.M.) has an enormously long letter of chat about Top Band. Mike's ladder score takes a sizeable lift, not so much by CW but rather by increased phone activity while maintaining his key-pounding at its normal level. However, one of the snags is the fact that there is an AM net just across the water which persists in operating on 1840 kHz ± their netting accuracy and spluttering into the bargain—how we wish some of these anti-social types would take up tiddleywinks or something! Back in January we mentioned the

GD4BEG loop arrangement of aerial which can be persuaded to give either high-angle or low-angle radiation to choice; now there is another such an aerial spaced broadside to the first by seventy feet to give a beaming effect by suitable adjustment of the phasing of the feed. By careful tuning and adjustment it seems to give almost 360° worth of rotation electrically; in addition some sixty radials of quarter-wave length or more have been laid down, some a bit longer, some a bit shorter, some zig-zagging round such minor obstructions as neighbours' houses and gardens (I) seem to have made a further significant improvement. Recapping since the last report, Mike worked 43 U.S. stations in W1, 2, 3, 4, 5, 8 and Ø, plus KV4FZ, HC1XG, HC1CW (both QSL via G8VG) and KZ5AA. On December 11 there was a contact with 457UD, who wanted to chat on even though half Europe were after him; but Mike didn't seem to have copied the 457's QSL address correctly and would *love* to know what it *really* is! Next we come to December 22, when W4BGØ/T12 and 9L1JT were hooked, and then the Christmas period, when GD4BEG admits to having missed much (Christmas feasting?) but nonetheless tickled with lots of W's, PY1RO, KV4CI, KZ5AA and KP4AN all on December 31, plus hearing KH6CHC up on 1998 kHz. This last is interesting because although the KH6 has been heard three times up there, and people have QSP'd that GD4BEG was hearing him, the KH6 was not hearing GD4BEG on his bottom-of-the-band frequency; W's report a similar phenomenon, which suggests that possibly there is much more difference between the skip at opposite ends of 160 metres at any given time than is generally realised. Perhaps someone should do some serious tests on this oddity. The morning of January 1 was particularly good, with VE7UZ, W7DOL/6 and W6DAO audible but no QSO made, plus, about half-an-hour after sunrise, ZL3RB and ZL2HE on 1876 kHz albeit weakly and under the QRM. On January 3, VE7UZ was half-worked, the QSO disappearing under a G station busily calling the VE7 *co-channel*. January 4 saw W9PNE and PY1RO worked; and on January 10 there was a contact with a station signing 9A1C, probably another manifestation of Fred Phoney. A trip into hospital rather damped the ardour for a day or two, but GD4BEG was out again in time for the CQ WW 160 battle; on the morning before the contest started things were FB with W's in areas 1, 2, 3, 4, 5, 8, 9 and Ø all worked at good strength. Mike was not able to be on for much of the contest proper, particularly the late-night and early-morning period, but still managed to make 175 stations in 23 countries, including 4X4NJ, OH3XZ/Ø, VOIKE, KV4FZ, I2XKF, ST2AY and W's—there seem to be several I's on Top Band, as well as the 9HI's, but all are good operators (not like the HF Italians) with good clickless signals too, although usually buried under hordes of OK's. January 28 saw a QSO with PY2FUS, and then on February 2 there were lots of W's and VS6DO to put in the log. OJØMA who was 569 on Eighty, was persuaded to come up on Top Band and there he was at about 599, getting weaker as darkness fell. February 15 saw a call from a W4/M4 in Florida who claimed to be on the move, but Mike awaits a card before thinking of that one too seriously, plus a QSO with JA6GG/MM in the Persian Gulf and one with a JA, believed to have been JA1GWF but not claimed as the identification was not 100%. And that, *mes amis*, is what you get on Top Band if you have a bit of room, a good site, plenty of wire under the ground and operating know-how!

The usual nice letter from G2HKU (Sheppey) came in this month, Ted commenting that things in general had been a bit rough; on Top Band he was down to the sked contact with PAØPN.

It must be quite a while since Top Band echoed to the call of the rare G2NJ-bird; but a late note from Nick assures us this has been happening, and among the first stations to be hooked were PAØPN at noon and HB9CM at 1750—the latter reminded Nick that G2NJ gave him his first post-War QSO. At midnight on March 4, UR2TAB was heard working OL3ØCBH, and a few minutes later UR2FQ raised a station in the Midlands.

G5BHR (Dorchester) is also F6DDY, although he has never used his French call, living in England ever since he has been licensed. About a fortnight before his letter he plugged a key into the rig for the first time, and the result appears—for the moment—at the bottom of the Ladder, although we are promised it will soon go a lot higher—good! Incidentally, all the G5BHR gear is home-built, this being a prime interest; the aerial is a bit of a problem, having 132 feet squeezed into a forty-foot space by putting five bends into it, and the highest I can go is about fifteen feet—and, to make it worse no radials or earth rods can be buried in the earth either!

Station of SM7FDN/MM, often to be heard on the North Sea trade routes. The car ferry "Vallan", 8000 tons, is on a regular run Wallhamn-Felixstowe-Ghent, carrying up to 400 new Volvo and DAF cars and tractors back from England. Gunnar Wigur, SM7FDN, operates on the 80-metre band (3523 kHz) at various times during the day and is QTHR or via bureaux.



GM3YOR (Kirkcaldy) writes to let us know he recently acquired a new rig, by way of an FT-101B which has been deployed on the bands to see what it can do. However, Top Band was not completely left out, as Drew was able to help the Glenrothes Club, GM4DMN/A, during the CQ WW 160 contest; after several years of participation the Club is quite pleased this year with its best result so far, 24 countries having been worked, in Europe DJ, EI, G, GC, GD, GI, GM, GW, HB9, OE, OH, OK, PAO, 4UI, and DX EP2BQ, KV4FZ, KV5AA, OH0MA, PJ2VD, VE1CD, VE3BMV, VO1KE, W6BYB/VE1, VS6DO, YV1OB and 4X4NJ, plus 45 W's in 23 States, only the sixth and seventh call areas being missing from the log. Drew mentions early that during the summer he will be out "doing" some more counties on Top Band.

Right at the last moment three more letters landed on the mat; so they must perforce receive only brief mention. G4BOH (Bury) wrote mainly to update his score in the Ladder, but he does mention one daylight SSB QSO of interest, namely that with G3WQF of Haverhill, Suffolk, when both stations were just readable at 1030 in the morning. At about 130 miles, this is definitely a bit above the 50-mile daylight maximum which G4BOH normally reckons on.

A rather unusual reason for QRT was mentioned by G4AKY (Croydon). It appears he has a conventional end-fed plus a rather elegant vertical which last was fed from a longish distance by a piece of coaxial cable lying on the ground. After using the aerial to some success on the Top Band U.S. stations over Christmas, time did not allow operations to resume till January-end. Consternation—feeder is now in six separate pieces! No, not neighbours' dealing with TVI, teeth marks at the breaks indicate the damage was done by foxes. So, Dave is, for the moment back on the end-fed wire. As school studies are at an important stage he does not reckon to pick up more than the odd point until June; but he means to go hell-for-leather after that to lift himself to a good score by the end of the Table year.

G4CBQ is another of these two-location types, he being normally operational from Southampton University and occasionally from home in Derby. At Southampton the rig is a home-built AM/CW job and a modified BC receiver used with 170 feet of inverted-L up top and a brace of quarter-wave radials; at home there is a top-loaded vertical used with an unspecified rig, which latter managed to cross the Pond several times during the Christmas holiday period. Phil makes out a well-reasoned argument for letting cross-mode contacts have some sort of rating, at least where Phone is concerned, he having polished off 39 counties from Southampton on AM of which only fifteen can be counted as AM/AM, the rest being AM to SSB; a valid point when we say the reason for the present scoring system is to encourage the "tiddlers" into activity. Fair enough, and retrospectively we will allow both sides of an AM/SSB QSO to claim two points; for the AM station that county is included in his AM counties list but at two points instead of three, while the SSB chap includes it in his list of SSB counties but at two points instead of one. This ruling means that a given county can still only be claimed three times, in the AM, the CW, or the SSB list—we aren't going to add a fourth dimension!

### Eighty

All sorts of funny things—both funny *ha-ha* and funny *curious*, come to think of it—happen in this area. There was a Fred Phone manifestation around, getting into Europe quite well and signing "BY9MAO," which caused a bit of a commotion. Whatever likelihood there may be of legitimate action from China, and it does seem as though the ice is slowly beginning to thaw, one can hardly imagine a legitimate Chinese licence bearing such a callsign—it'd be sacrilege.

Nonetheless, the old maxim that LF DX tends to improve as the sunspot count falls is still, in the general sense, true.

G4BKY (Dursley) has got an 18AVT up now, and his been giving it a run on all bands. On Eighty the SWR is rather high except around 3580 kHz and in that region Steve worked a few Europeans including LB3P and DJ3WG.

For G4DMN (Shrewsbury School) Eighty is, he says, the favourite band—except when the DX doesn't come back! And, as to that, he adds his country score is now 93 worked and at least twice 93 got away! From school, Richard succeeded with C31LO, EA8JP, EA8EX, HV3SJ, JX2HK, TA1MB, UB5BU, WIEBC and LU1BAR/W3; from home during half-term when the OM was pushed to one side of the home shack, G4DMN made it to AP2KS, ZL2BT, 4X4QG (all new countries on the band) plus FC2CD and YV5AMJ. The Morse key has also been plied for the first time since the ticket was obtained, but so far not much has been raised, and all of it in Europe.

The suggestion of a possible QRP net on 3550 kHz prompts G2NJ (Peterborough) to comment that he heard several well-known QRP types, including G3DNF and G3FMW, at workable strength on February 9. Nick's noontime operations have also turned up trumps, with a call after working a G2 old-timer coming from DJ1FE with five watts and a fine signal.

Now we come to G3CED/G3VFA (Broadstairs) with an extensive log of stuff worked, mainly on Eighty, using alternately his PM3A rig and the Heath HW-7, to a Joystick; one of the noticeable things is that when swapping reports with a station using, say 100 watts, there is so little difference in strength reports each way from G3CED's five watts—for example, working G4BPV in Redruth George passed out a report of RST 459 to the hundred-watter and got for his five watts a report of RST 549! The Joystick and five watts got round to a total of twelve countries on the band during the period.

G2HKU continues his QRP researches, and managed to work HZ1KE, and K3GJD on the big rig SSB plus F8MS on the tiddler CW, for which the batteries are now down to 10 volt—and that with a series/parallel arrangement! The scheme is to see how far down they can go before the PM2B refuses to receive any more! The general feeling Ted gets about the band is that by and large it is perking up a bit—let's hope he's right.

### Forty

What a waste of a good band! Quite seriously, this old scribe feels that 7 MHz is probably the most reliable area in which to pursue the elusive DX trail, at least while the sunspot count is so low.

G4BKY found his FT-DX401 plus 18AVT worked out well, and on 7 MHz QSO's were registered with (CW) WA2BLV, K2DNU, W3BGN, W1CY, W2AXZ, W2ETM/4, WA2MPH, K4JM, WA2ITR/1, WB2IVK, W3ARK and WA1SCV, not to mention hearing PY7's and VK3MR, VK3HD.

Back at school, G4DMN reckons this is the Headache Band! His best offerings were CT2BP and a UK3LAC—never mind, practice makes perfect!

The only other correspondent is G3CED/G3VFA, who cut his Joystick feeder down to thirty inches, and pumped his three watts into it to work Europeans quite happily.

At which point, one cannot but wish that one of the 7 MHz dabsters of yore—say, GM3JDR, for example—would come back to the band and show us just what can be done by a skilled operator both on CW and SSB.

G4CXM (Bristol) is nothing if not a sticker, and he tried 40 meters once. The result was CW to KP4WL, UI8UR and a one-watt signal from YO3KDP/TS—wonder what the TS means?

G2HKU seems to have given the band a good whirl, and reports SSB contacts with HK4CKT, HK4DHR, VP1FF and VO1KE, while CW brought up VE2WW, VE3BMV, VE3BWW (perhaps recalled by many an OT better as G6WY) and UM8MBA, a couple of hundred miles from the Chinese border.

### Twenty Metres

As usual, most of the activity has been around this area, although few people feel their results are worth reporting; indeed, many of those who would normally be sending in reports will have found that at times they could be on the band and pretty well dead to the wide.

G3CED and his Joystick plus QRP rigs had a go in the CW end, and found some interest in comparing results with five watts from the PM3A against the HA7 with just two watts, trading reports at R5 with OH2KP, UK1AAG, SM2FZA, UN1BR, UV3NA and a local in G3FTE (Margate).

Surprisingly enough, the school set-up gave G4DMN: JY9MS, G3ZGC/MM off Portugal, G3ZXH/MM near Malta, VP2MDG, UD6CC, U30G in Moscow, ZC4AK, 7X2AG and 4S7SW, while the home half-term break was used to work CG3GCO, EP2DB, HC1BU, VP2VBK and YV4ACY; and a single Sunday at home produced lots of W's in the contest, also FP0MM and 7Q7DW. On a side-track for a moment, Richard was amused to watch "Cannon" on the goggle-box, looking for "bugs" in a room with a sniffer which was exactly the same breed of SWR/FS meter as the one used by G4DMN! It would be nice to know how they detect bugging with an SWR meter!

On to G4BKY, who found CW the only answer as any attempt to go SSB resulted in TVI: the CW produced bookings with ZS6SS, ZS6ME, ZS5BS, WA7NDB, W7NW, W7DPW and W7VY (all in Washington state) many VE's, W1, W2, W3, W4, not to mention a few PY/LU stations. Steve reckons his TVI is getting through the mains, and so

## Reporting the HF Bands

is going to build up a suitable mains filter—let's hope it does the trick, although old 'KFE, from painful experience, would suggest that the rig being clean on CW is simply saying that as soon as the PA gets a whiff of grid current as the ALC takes hold, the harmonic content goes up with a bump and is strong enough against most low-pass filters to upset the appletart—here we have two LFF's, plus a tuned stub, to ensure clear operation with the full whack and the ALC biting.

Back to our muttons. G4CTR manages to get pleasure out of Twenty, his FT-101 and 132-footer having been used to exchange reports with ZL1AH, HG104UA, W7KSA, VP8NP, K6PIZ, WA7PMI, VE7SV, 7X2BK, IC8TRA and JY9MS.

Now we come to the Big Guns, by way of G3NOF (Yeovil) who found Twenty the best of a job lot of bands. Mornings to VK/ZL have been pretty punk, few of these and no Pacific stations having been heard; evenings have been fair to Africa from 1700 to 2030-ish, sometimes as late as 2345, and of course the W's were around at about the same times. SSB contacts were made with A2CCY, A2CJP, C5AU, CN8DX, CY6AGV, CY6ATR, CY6GD, CY6GQ, CY6TB, EP2DB, HK3BGN, JA1JAN, F6AXV/MM, in Zone 39, JY9CR, JY9MS, K0KKU (Colorado), TR8BJ, TR8CM, TR8DG, TR8VE, TU2EG, TU2FA, TU2FO, VE6ANN, VE6OJ, VE6VG, VE7UBC, VP1PW, VP2EEC, VP9HS, VQ9GP, XT2AE, ZD7FT, ZE1DP, ZE2JK, ZS1DG, ZS4PB, ZS6AD, ZL4PJ, W7YL, WA7GWU (Utah), W0ONL (S. Dakota), W0SYB (Colorado), 4W1ED, 4S7SW, 5R8AA, 5T5CI, 5T5GS, 5T5ZR, 5U7AW, 6W8AAD, 6W8DY, 7Q7LB, 7X2BK, 9J2B, 9J2DT and 9J2LL.

As we said earlier, GM3YOR has a new FT-101B and is trying it out on the HF bands; so far on Twenty he has hooked VE8ML, W1, W2, W3, ZB2A and 9J2WR on Sideband, plus a CW QSO with ZS6SM.

Nice to hear again from W4WFL/1 (Farmington, Conn.). Morgan tried the key during the REF contest and netted a couple of new ones in FR7A1/T and 5R8AA; for the Phone weekend things were nothing like so good although he did bump into 4S7SW and hooked him for another new one although not counting for contest credit.

Like most others, G4CXM doesn't think a lot to the spring lift this year; Twenty seemed to be in the doldrums whenever he could get on, although he keyed with PY7AHO, YV5TT, UK9WAP and "phoned" to TG9PW, YV7BI, 6W8DY, 5T5CI, VK3XK/P, CG3CGO and HV3SJ.

Lousy! That's the report from G2HKU; his ZL1 skeds which were 57 on SSB this time last year are now down to RST339 on CW! However, on SSB there were ZL3SE and JH3DPB/P/1 while CW gave ZL1VN and 4Z4PI.

### Top Band Counties

October — September

Call sign	AM	CW	SSB	Total
G4BEG	15	138	40	193
G2BJY	12	130	31	173
GM3YOR	—	120	30	150
G4AKY	—	94	24	118
G4BWP	27	70	—	97
G4BOH	9	48	18	75
G4AYS (QRP)	—	66	—	66
G4CBQ (home)	—	—	—	53
G5BHR	3	32	—	35
G4CBQ (Univ.)	30	—	—	30

Each county may be worked once in each mode. AM contacts score three points, CW two points, SSB one point. AM contacts made by charging over to AM from SSB are not allowed, neither are cross-mode contacts saving that AM/SSB contacts will be counted two points claimed for the mode the station was using, e.g., the station on AM claims his two points under the AM heading, the SSB end claims his two in the SSB list. New U.K. County designations apply.

Starting date October 1 1974, closing September 1974.

### Ten & Fifteen

Lumped together this time as there is hardly enough to justify a separate section to each.

G4CXM seems to have stuck to SSB on 21 MHz, where he made QSO's with CR6WT, ZE1EA, ZS5PU, OD5HC, G3ZGC/MM (of recent reports to this piece, who was off EA9) and gotaways were A2CCY and 3B8CV. Ray did not bother with Ten at all. Just one contact was made on 21 MHz by G4DMN, namely VP2EEE.

Fifteen CW gave GM3YOR contacts with A4XFP, EP2SN and KV4CI, and there was just one sideband QSO, with 9G18AA.

Even G3NOF found the going rough; Don heard Africans up to 1400 and some openings to VK6 and Asia, very few W's being heard at all. Sideband contacts were registered with CR6WT, HC2YL, VK9XR/MM (on a yacht between ZD7 and ZD8) VQ9NEW, VU2ABC, ZD7FT, ZE7JW, ZS2EM and 9G18AA, although 5T5GS and 7P8AT both got away. The only time Ten was noted to be open was on March 9 between 1000 and 1200 when VQ9HCS, ZE1EI, ZS6BKS and 9J2DT were logged.

Nothing has yet been worked by G4BKY on Ten, a sked with EA8GN being abortive; on Fifteen, CW accounted for EA8GN and 9H1CH.

A little more luck was had by G4CTR, with KV4AD, VK6HE, 9G1OY, PY0ZAE, ZD7FT, ZS2MN, ZS5MQ, YV5ESN, A2CCY and CR7JO all worked on Fifteen, many of the contacts on this band being with the aid of a one-element Quad at ten feet, which seemed to work quite well. Nothing was noted on Ten.

HB9KC is operated by Werner Bopp, P.O.B. 83, CH-3073, Guemligen, in the Canton of Bern. He has a nice range of modern gear, QSL's via bureaux and writes English.

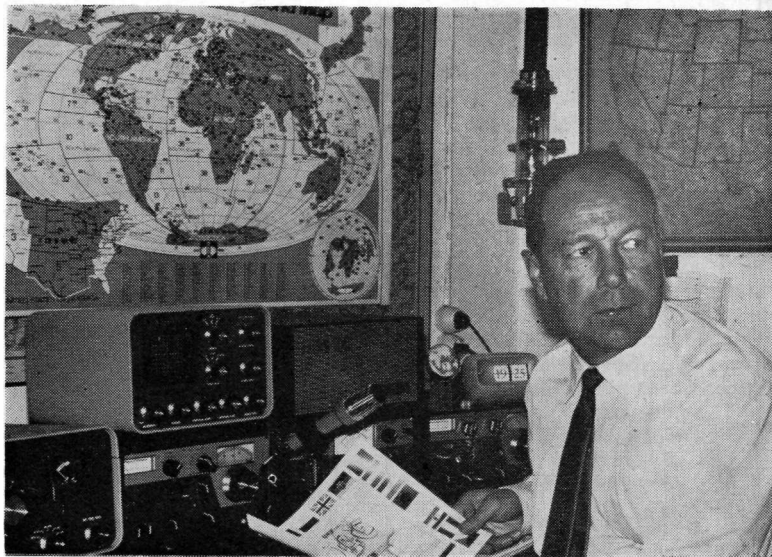

#### This & That

Robbery is the proper name for it; as fast as the postal service deteriorates so do the postal rates rise. The current change will bring the cost of second-class postage up, first-class postage likewise, and the cost of an IRC for Overseas will now be no less than 13p! This old scribe suggests you all go down to the local Post Office and obtain the three brochures, one each for Inland, Overseas, and Forces Overseas. Once that is done, the next move is to send your QSL Bureau chappie a supply of envelopes at the new rate, or stamps to make up the value on the envelopes there. And, finally, we might comment that QSL'ing direct is going to be pretty prohibitive, so an increased proportion of traffic, like it or not, is going to be routed through the Bureaux.

Talking about Bureaux leads us on to QSL tactics. W4WFL/1 had a couple of stickers who failed to respond to QSL's plus s.a.e.'s, repeated several times. Eventually, Morgan sat down and "home-brewed" a QSL card to each one, which required the DX station to do no more than sign his name to authenticate. When sent off both came back signed within a couple of weeks and both are valid for DXCC use.

G3RJV wrote on various points and one interesting one is that his mail leads him to believe many QRP operators have expensive QRO gear just gathering dust in the shack, although there are of course some of the chaps for whom QRP is a matter of reduced costs.

On that score one has to admit that G3CED/G3VFA, whatever his likes and dislikes in the aerial line, is a real QRP enthusiast; in his latest letter which arrived too late for detailed comment, one thing he says is that two watts is far too much to put up the feeder; what he now proposes is to go QRPPP for a period of time and see what that yields as compared with the two-watt power!

G2HLU (Reading) returns to the lists, he having at the time of his letter just finished operating in BERU during which Harold was pleased to find that 7/14/21 MHz were up on last year's contest but Eighty most definitely "down." On a different tack, G2HLU has been at work redecorating the shack, and he took advantage of the clear-out to re-think the furnishing of that holy of holies. The old Handy-Angle rack at which he used to sit—shades of R107 receivers and hundred-weight transmitter PSU's!—has been discarded and the new G2HLU sits at a nice convenient desk-style operating position. Furthermore (this is really earth-shattering!) he has bought a *microphone!* Now his Vespa, which he has had for a couple of years or more, can be fired on SSB, and G2HLU found this strange experience of operating without a Morse key to be actually rather enjoyable. After about forty years of key-punching that really is a change; but it does imply that the mind is still open to be convinced by logical argument that something different or new is not necessarily also bad. One only wishes that those who make a "sacred cow" of any and everything new or modern would also display a similar flexibility of mind!

If you come across G3LSQ/MM, Peter is *en route* to the Leeward Isles in his 24-ton yacht *Lucina*; he keeps a daily sked with G3FWB of Northampton at 1045z on 14275 kHz.

ON4QX (Antwerp) says he doesn't know much about Amateur Radio, although he has 307 confirmed on Twenty and 327 on Fifteen! To brush up on theory, Bob is doing a B.I.E.T. course on R.A.E. and in this connection seeks back-copies of old papers for his collection. He also remarks that our R.A.E. is much more difficult than the qualifying exam. in Belgium! Incidentally, as many will know, Louis Th. Berge was a Radio Officer Lt. in the Royal Navy and Combined Forces during Hitler's War. He sends his 73 to all his old buddies from Dunkirk, Walcheren and D-Day. Give him a shout—on CW. of course.

Last time we heard from G8HX (Mansfield) he was in the wars with his DX-100 in which one of the inductors caught fire. Frank is now back in normal operation, his replacement being an output choke out of a junked T.1154 Tx! But what odds if it *works!* On a different line, G8HX has received the Nicolaus Copernicus award which to his pleasure was endorsed as the first G8 qualifier. Once more a change of tack, and referring this time to standard-frequency transmissions; as G8HX points out, in many parts of the U.K. the Russian 15 MHz signal is probably the most useful most of the time—but they also have a standard just five kHz away on 15005 so be careful you latch on to the right one before checking the wavemeter! Worth remembering, that.

Myrtle Cunningham, WA6ISY, YLRL vice-president, sends the result of the North American YL-DX YL contest in January, from which we notice that the honour of the G's was well upheld by G8LY both on Phone and CW—Congratulations.

Finally in this section we have to hand a note to remind us of the Bermuda Contest. *Phone* is April 19-20, *CW* May 3-4. Times 0001z Saturday to 0200z Sunday. Rules are pretty well the same as in past years saving that the VP9's will still be sending their parish in the exchange but the multiplier will not be related to parishes but to the number of VP9 stations worked on each band. We send RS(T) plus State, Province, or County. U.K. stations can work VP9, VE/VO, or W/K, while W/VE/VO operators go for G or VP9 stations only. Winners get round-trip plus one week's accommodation at the Bermudian Hotel to attend the Bermudian Society's annual banquet and receive their award. For full details, in a coloured brochure *cum* rules-sheet, send an s.a.e. pronto to G. Beasley, G3LNS, *QTHR*.

#### Conclusion

Space has run out on us again; when we started this time there was next to nothing on the clip, 'cos everyone left it to right on the deadline. Please make it on time, or even if you can a wee bit early, deadline for our next, first post arrival April 8, addressed as always to: CDXN, *SHORT WAVE MAGAZINE, BUCKINGHAM, MK18 1RQ.* And 73 to all.



## MOBILE RALLY SEASON—1975

With three more Rally dates notified, we now have a total of 14 for the Calendar, one of which (the White Rose at Leeds and the earliest in the Season) will be taking place just as this appears.

Organisers, and free-lance amateur picture-takers, are asked to let us have reports and photographs covering Rally events as they occur. Any photographs we can use will be paid for on appearance—but when sending in a print, please give full details on a separate sheet, *not* pencilled in on the back of the photograph itself except as may be necessary for identification purposes, e.g. "Photo A, Hogsnoton Rally, 23/4/75," or whatever, the details then being given separately and referred to "Hogsnoton, Photo A."

Also, we cannot accept negatives nor film-strip and we prefer black-white prints rather than coloured.

All such material should be addressed to: "Mobile Scene," SHORT WAVE MAGAZINE, BUCKINGHAM, MK18 1RQ.

## MOBILE RALLY CALENDAR

**March 30:** White Rose Rally at Lawnswood School, Leeds, junction A.660/A.6120, with many trade stands (some new to the Rally scene), a raffle, well-stocked canteen facilities, ample free parking and talk-in. Local travel by Leeds Metro No. 1 service, railway station to School.—Miss C. Wade, G4CUY, 74 Cow Close Road, Leeds, LS12 5PD.

**April 20:** North Midlands Rally at Drayton Manor Park, near Tamworth, Staffs., on the A.4091, and within 12 miles of Intersection 4, M.6, with local AA sign-posting.—A. R. Walton, G3ZKQ, *QTHR*.

**May 4:** Tulip-Time Rally at Gleed Boys School, Halmer Gardens, Spalding, Lincs. within walking-distance of the 20-acre Springfield Gardens, with flowers and fresh vegetables for sale. All regular attractions, talk-in by G4DSP/A on 1980 kHz and G3MMS/A on 145 MHz, ample free parking, refreshments, bring-and-buy stall (no junk), raffle, prize for longest distance travelled, location maps available on request.—R. Harrison, G3VPR, Spalding & District Amateur Radio Society, 38 Park Avenue, Spalding, Lincs., PE11 1QX.

**May 18:** Amateur Radio Mobile Society Rally is cancelled.

**May 25:** Hull & District A.R.S. Rally at East Riding College of Agriculture, Bishop Burton, Beverley, Yorkshire, as in previous years.—L. D. Colley, G3AGX, 13 Ferry Road, Wawne, Nr. Hull, Humberside, HU7 5XU.

**May 25:** Maidstone Trade Exhibition and Mobile Rally, Y-Sportscentre, Melrose Close (off Cripple Street, A.229), Loose, Maidstone, with talk-in on 160, 80, 4 and two metres, signing GB3YSC. Trade stand enquiries to A. S. Walters, G3WXL, 4 Oak Farm Gardens, Headcorn, Ashford, Kent.

**June 1st:** Royal Naval Amateur Radio Society Rally at H.M.S. *Mercury*, near Petersfield, Hants.—Fleet/CRS M. J. Matthews, G3JFF, R.N.A.R.S., H.M.S. *Mercury*, East Meon, Petersfield, Hants., GU32, 1HE.

**June 8:** Sixth Mobile Rally at Elvaston Castle Country Park, south of Derby, off the B.5010.—P. Neal, G3WUF, *QTHR*.

**June 29:** The 18th West of England Rally at Longleat House, Warminster, Wilts., probably one of the finest Rally sites in the country—further details later.—B. Croker, G3ULJ, 36 Portland Street, Staple Hill, Bristol, BS16 4PT.

**July 6:** Worcester & District A.R.C. Rally event at Upton-on-Severn, as in previous years.—B. Jones, G8ASO, *QTHR*.

**July 20:** Cornish Radio Amateur Club annual event, at the Technical College, Pool, Redruth, Cornwall. (*Details later.*)

**August 17:** Derby & District Radio Society annual event at Rykneld School, Bedford Street, Derby, as in previous years. Details later. Information from T. Darn, G3FGY, 1 Sandham Lane, Ripley (2972), Derby.

**August 24:** Torbay Amateur Radio Society Rally at Newton Abbot Rugby Club ground, as in previous years.—L. H. Webber, G3GDW, *QTHR*.

**September 28:** Harlow & District A.R.S. event at Netteswell School, Harlow, with bring-and-buy and Trade stands, refreshments, free admission and parking. Details: C. West-Bulford, G8JXU, hon. secretary, Harlow Amateur Radio Society, Mark Hall Barn, Harlow, Essex.

## SPECIAL-EVENT STATIONS

The forthcoming dates notified for appearance under this heading are:

**GB3RN, March 28-April 7:** From H.M.S. *Belfast*, the historic cruiser now at permanent moorings in the Pool of London. Amateur Radio activity on all bands, HF and VHF.—D. F. J. Walmsley, G3HZL, 153 Worple Road, Isleworth, London. (*Tel.*: 01-892 3239, evenings and week-ends.

**G3UOK, April 26:** For the University of Keele Open Day, to celebrate their 21st anniversary, running 20-80m. and two metres. All contacts will be QSL'd. Visitors are invited to Room 117, Chancellor's Building. The University is two miles west of Newcastle, Staffs., on the A.525 and near the A.34 and M.6. Location maps available on request.—V. J. Reynolds, G3COY, Dept. of Communications, University of Keele, Keele, Staffs., ST5 5BG. (*Tel.*: 0782-71 371, *Extn.* 128).

**GB3NRS, April 27:** Northern Radio Societies' Association station, Bellevue, Manchester, for the annual convention of these groups. Stations G3WDH and GB3NRS will work all bands Top to two metres. Many attractions for visitors at this well-supported annual event in the North-West.—D. C. Mott, hon. secretary Otley Radio Society, 17 Newall Carr Road, Otley, West Yorkshire.

# QRP ON EIGHTY

CO/PA Tx RUNNING THREE WATTS—ADAPTABLE FOR TOP BAND OR FORTY— ALL-TRANSISTOR DESIGN

G. J. BENNETT, B.Sc., Ph.D. (G3DNF)

*Our contributor is a well-known exponent of the art of QRP/CW working. The Tx design he discusses here is easy to build and is capable of very satisfying results for those more interested in finesse than in "blasting through" at whatever cost.—Editor.*

THE popularity of low-power CW on 80 metres becomes very evident by operating for only a few hours on this band. It is fairly certain that a contact with at least one QRP station will result.

Low-power operation has a fascination of its own, as every QRP enthusiast will agree. For the present purpose it is enough to say that QRP provides an interesting challenge, both in operating and in construction. The growing interest in QRP has been fostered by the availability for and acceptance of transistors in RF power applications. Energy conservation awareness is now providing an additional stimulus.

For anyone tempted to try QRP there is a bewildering choice of D-I-Y designs, some of which appear to be dauntingly complex, or may require components which are hard to obtain. The alternative is to purchase a ready-made QRP transceiver. Several models are available, though the price may seem high unless the purchaser is already convinced that QRP really works.

Building a CO/PA transmitter is probably the best way to make a start with QRP CW. Before the advent of transistors, in those far-off days when every newly-licensed "G3/3" had to put in a year of CW-only operation, a CO/PA transmitter could be found in most shacks. It is still possible to get on the air quickly in this way by using those same old valves or by going in for transistors.

The transistor transmitter described here is simple to construct and get going. It also gives enough output to make itself clearly heard.

### Technical Description

A Pierce crystal oscillator (2N706) is capacity coupled to the PA (BFY52). The PA has zero standing bias and is driven into forward conduction by rectification of the drive signal at the base-emitter junction. The total lack of PA bias components looks odd at first sight but it is intentional.

Low-impedance output suitable for a link-coupled ATU is obtained by means of a toroidal transformer which delivers RF via a series-tuned LC circuit.

When receiving, the crystal oscillator can be switched on as required for channel checking or "netting." For this purpose the oscillator runs at reduced voltage, supplied by a dropper (R4, Fig. 1).

On "transmit," the crystal oscillator runs con-

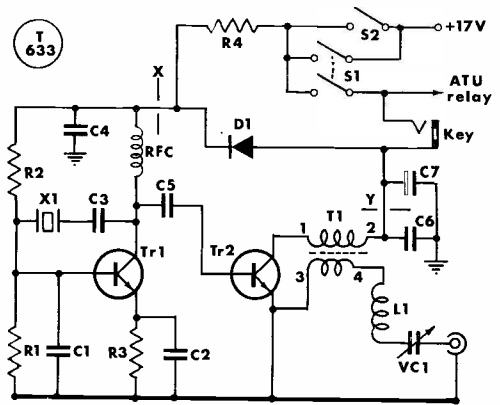

Fig. 1

Fig. 1. Circuit diagram of the QRP Transmitter

### Table of Values

Fig. 1. Circuit Diagram of Transmitter

- C1 = .001  $\mu$ F poly-styrene
- C2, C4, C6 = 0.1  $\mu$ F ceramic
- C3, C5 = 120  $\mu$ F poly-styrene
- C7 = 1  $\mu$ F
- VC1 = 750  $\mu$ F mica, compression trimmer
- D1 = 1N914
- R1 = 2,200 ohms
- R2 = 22,000 ohms
- R3 = 100 ohms
- R4 = 3,300 ohms
- RFC = 1.5mH RF choke
- Tr1 = 2N706
- Tr2 = BFY52 with clip-on heat sink (see text)
- L1 = 30 turns of 28g. enamelled copper wire, close wound single layer on Aladdin former (7mm. diam., without tuning slug).
- T1 = See Fig. 4. Primary, 4 turns of 28g. enamelled evenly spaced on stack of 3 ferrite beads (FX-1115); Secondary, 1 turn of pvc-insulated wire threaded through stack after winding Primary.
- X and Y are metering points—see Fig. 2.

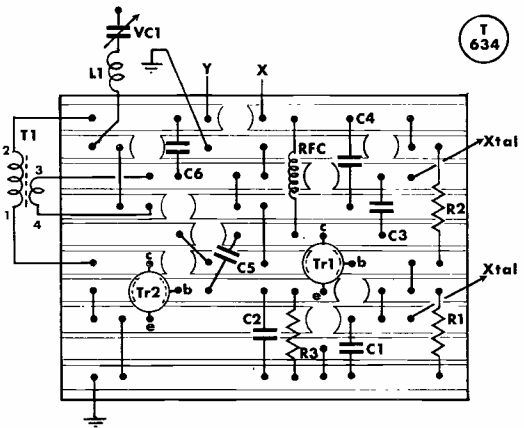

Fig. 2

Fig. 2. Suggested layout using 0.15-in. Veroboard, viewed from above

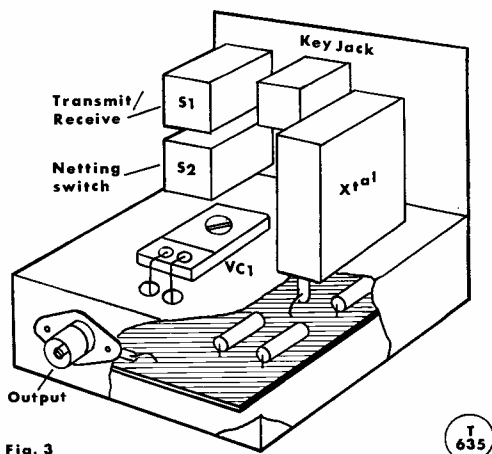

Fig. 3

T  
635

Fig. 3. Suitable method of construction, cutaway view

tinuously, but receives full voltage (via D1, Fig. 1) only when the DC supply to the PA is keyed. This method of keying is better than keying the PA alone, which does not give enough RF cut-off between characters.

### Construction

In order to make use of the existing PSU, control circuitry and ATU, this Tx was originally constructed as a module rather than as a self-contained item of equipment. In this form it was built in an aluminium chassis box (3 x 2 x 1 inches) with key jack and power socket mounted on a small external bracket.

For the convenience of other constructors, the circuit as shown (Fig. 1) includes "netting" and changeover switches. If small enough these could also be mounted externally (Fig. 3). The addition of a suitable power supply and ATU will then complete the transmitter.

If receiver muting is also required, this can be arranged by means of a suitable relay, energised in the same way as the aerial change-over relay (Figs. 1, 5). Alternatively, the facility can be provided by having an additional pole on S1 (Fig. 1).

Most of the components can be mounted on a small piece of Veroboard (0.15 inch matrix), mounted inside the chassis box by using short lengths of 22g. tinned copper wire to complete the connections to the crystal socket and earthing points (Figs. 2, 3). Other components can be mounted as shown in Fig. 3 (L1, which is not shown, can be attached to the inside of the chassis box, in the space below VC1).

### Components

The only component requiring comment is the toroidal output transformer, upon which depends the efficiency of the PA. Ferrite toroidal cores are often specified for coils and transformers in the design of transistor transmitters. In many instances the choice of core is critical and the selection of an equivalent will depend upon a number of factors, which include dimensions and grade

of ferrite. Some grades are unsuitable for RF power applications.

In developing this transmitter, many different toroids were tried, most of which performed fairly satisfactorily. By far the best core was found to be a tubular stack of three parasitic stopper beads, type FX 1115 (Fig. 4). This also makes a very cheap and easily available core. Similar results, but with slightly lower efficiency can be obtained by using a tubular ferrite tuning slug from an Aladdin coil former (N.B. Ferrite is a hard, stony material which cannot be scraped with a knife).

### Setting-Up

Carefully check the circuit board and connections before connecting the power supply. Next, see that the crystal oscillates when the netting switch is closed.

Adjust VC1 (Figs. 1, 3) to maximum capacity and connect a flashlamp bulb (2.5v./0.3 amp) to the output socket of the transmitter. Switch to "transmit" and check the PA function by briefly connecting a milliammeter across the key socket. Normally, a reading of

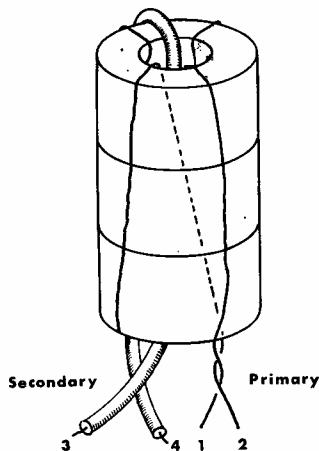

Fig. 4

Fig. 4. PA output transformer (T1, Fig. 1) general arrangement

T  
636

T1 is wound on a polypropylene tube  $1\frac{3}{8}$  inch O.D. (e.g. as used in plumbing). Main winding is 60 turns 24g. enamelled, close wound, with several tapping points at intervals of 10 turns. Link winding 8 turns of pvc-insulated "connecting wire" overwound at the "earthy" end of the main winding.

For 160 metres, T1 can be 100 turns of 32g. wire with 10 link turns.

For 40 metres, 40 turns of 24g. and 6 link turns are required. These values are suitable for an end-fed aerial of  $\frac{3}{8}$  to  $\frac{1}{2}$  wavelength, e.g. 90 feet for the 80-metre band.

The choice of relay will be governed by availability. A suitable type is 354/12v. (Magnetic Devices Ltd.), which has low capacity contacts, a coil resistance of 325 ohms, and operates on 12 volts DC. There is plenty of scope for trying other types.

between 50 and 150 mA is obtained, and the lamp will probably light.

Tune VC1 for maximum output while keying a string of long dashes. Maximum output at 3.5 MHz will require a high setting of VC1 and will light the lamp to full brilliance. Avoid tuning the second harmonic, which will require a low setting of VC1 and will only dimly light the lamp.

When correctly adjusted on the dummy load, typical current readings at metering points "X" and "Y" (oscillator and PA respectively) would be about 10 and 100mA.

If the transmitter appears to be functioning correctly, connect the ATU and aerial (with the dummy load still in circuit). Key the transmitter intermittently while tuning the ATU for maximum absorption, so that the lamp is extinguished or at minimum brightness. Disconnect the lamp and continue tuning up with the aid of a sensitive absorption wavemeter or field strength indicator. Tune for maximum radiated signal, adjusting VC1 and ATU successively. With experience, this procedure can be shortened, once the optimum settings are known. As a general rule, if the aerial is tuned correctly for reception it will need little further adjustment for transmitting.

Before the final launching ceremony, it is wise to monitor the transmitted signal, to ensure freedom from chirp, parasitics, clicks, strong harmonics and TVI. This transmitter has been found to be remarkably free from such defects, but it is always worth checking the list when putting a new Tx on the air. With regard to harmonics, bear in mind that a strong harmonic detected on the station receiver is *not* a good guide to the amount of harmonic power radiated. The use of an absorption wavemeter or field strength indicator is better for this purpose.

### Hints and Wrinkles

This little transmitter should be found easy to get going and free from snags. The following comments may be found helpful if any difficulties are encountered.

If the oscillator fails to perk, recheck the wiring. If all is in order, a change of transistor may do the trick. A crystal that is not active enough may fail to oscillate, or may oscillate weakly or start slowly. Reduced oscillator output will give low drive to the PA, which in turn will fail to light the lamp.

Should the output from the PA be less than expected, try another transistor here also. Other types which can be used include BFY50 and 51, 2N3053 and 40311, although some makes of the BFY50/51/52 series are less effective than others for RF power applications. Most transistors of these types will run at about 2 watts input in this circuit when properly loaded. Exceptionally, one can be selected which will run at 3 watts, but will also need greater care in avoiding a load mismatch during the tuning-up procedure.

The transmitter will run at about one-watt input on a 12-volt supply. For 40-metre operation, all that is needed is a crystal for that band and a suitable ATU

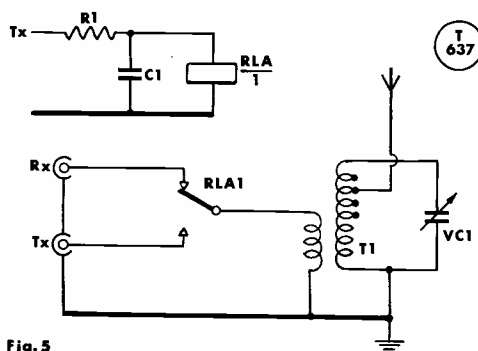

Fig. 5

Fig 5. ATU suitable for end-fed aerial—90 to 150 ft. on 80-metre band

Fig. 5. Aerial Tuning Unit. C1 = 0.1 $\mu$ F ceramic; VC1 = 100 $\mu$ F airspaced; R1 = 220 ohms.

(Fig. 5). The setting of VC1 will be lower for this band. Top Band operation can be achieved similarly, but in this case it is necessary to connect an additional capacitor (15 pF, polystyrene) in parallel with VC1.

Particular attention should be paid to the quality of all connections especially in the ATU, as a dry joint can absorb much of the RF generated by a QRP PA!

The power supply can be a bank of dry cells. If a mains power pack is used, it is preferable to stabilise the voltage. A zener diode or a more elaborate regulator can be used for this purpose.

### Results

Much of the enjoyment of QRP comes from the recognition and exploitation of its possibilities. When conditions are good, opportunities occur for surprisingly good contacts to be made. However, QRM and QSB normally make it harder for the QRP signal to get through. Calling CQ tends to be a waste of time with QRP. It is usually better to search for likely contacts. When using crystal control, the best method is to lie in wait for calls occurring within 1 kHz of the frequency in use. If several crystals are used, each channel may be monitored in turn.

A glance through the CDXN columns of recent issues of SHORT WAVE MAGAZINE will give some idea of what can be done with QRP on Eighty. Results with this Tx should be similar to those reported by several stations using a couple of watts. Contacts within U.K. and Western Europe can be made quite easily.

The importance of the aerial in QRP operation must always be stressed. Experience of using low power for many years has shown that correct tuning of the aerial is the most important factor. Get it "on the nose" and you will be surprised how far a few milliwatts will go.



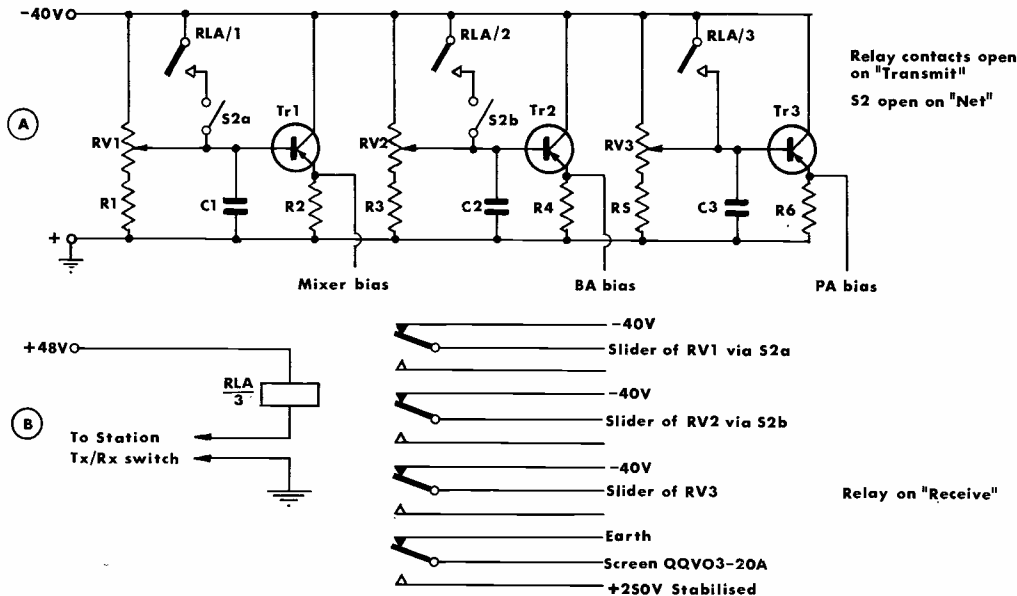

Fig. 6 (A) Bias circuit. (B) Relay Switching

Fig. 6. Relay and Bias control circuits

converter. Connect the output to the mixer chassis via an SWR bridge and adjust the output circuit and the input circuits of the mixer for maximum grid current in the mixer, having temporarily disabled the bias to the stage and inserted a 5 mA meter. Ensure that the bridge indicates minimum reflected and maximum forward power. Apply screen and anode voltages to the mixer and set the mixer bias at  $-7v$ . The anode current should then be about 16 mA. Apply a small amount of 28 MHz drive until the anode current just rises. Check with the GDO that the anode circuit resonates at 432 MHz. Do not run the valve above 30 mA for any length of time—the plate dissipation is only 6w.

Resonate the grid circuit of the buffer amplifier, checking again that you are on 432 MHz and not 404 MHz, apply anode and screen voltages and adjust the bias for 25 mA standing current. Modulation will kick this up to 45 mA with about 15 volts of bias. Bias voltage may be  $\pm 1$  volt or so—the important thing is the standing anode current value. The measured output under key down conditions was  $2\frac{1}{2}$  watts.

Using the SWR bridge as before, adjust buffer amplifier tuning and loading and PA grid circuits for maximum transfer of power with minimum SWR. A meter in the QQV03-20A grid circuit will indicate this. With  $-25v$  of bias on the PA, and a dummy load on the output, apply anode and screen voltages and set the standing anode current at 25 mA. This will rise to about 75 mA on speech peaks at resonance. Load up for maximum output and then increase the loading until the speech peaks drop by about 10%. Measured output from the prototype was just 10 watts.

Just to run through the main points again: With

**Table of Values**

Fig. 6. Bias Circuit

RV1, RV2, RV3 = 100,000 ohm linear wirewound pot.	R5 = 20,000 ohm, $\frac{1}{2}$ watt
R1, R3 = 10,000 ohms, $\frac{1}{2}$ watt	C1, C2, C3 = 0.1 $\mu$ F, 50v. wkg.
R2, R4, R6 = 20,000 ohm, 1 watt	Tr1, Tr2, Tr3 = BCY30

all circuits resonant at the correct frequencies and the right level of drive to each stage, the mixer should draw 16 mA standing current which should rise to about 18 mA, and no more, on speech peaks. The buffer amplifier standing current should be set at 25 mA and should go up to 45 mA on peaks of speech. The PA standing current should be 25 mA and should rise to about 75 mA on peaks. No grid current is drawn by any stage.

If you do not attain these figures, the most likely trouble is incorrect alignment of the mixer and buffer amplifier stages. Adjust SSB drive by varying the spacing between the input loop and grid line of the mixer. Do not do so by cutting down the audio gain control on the prime mover—you will only achieve an unbalance between carrier and sideband which will impair the quality and cause a carrier to be radiated. Do not operate the PA with screen volts applied and no anode volts and do not operate it except into a load, dummy or antenna.

It will be noted that HT is applied to all valves as soon as the PSU is switched on. On "transmit," normal operating bias is applied to all stages. On "receive,"

VO  
272

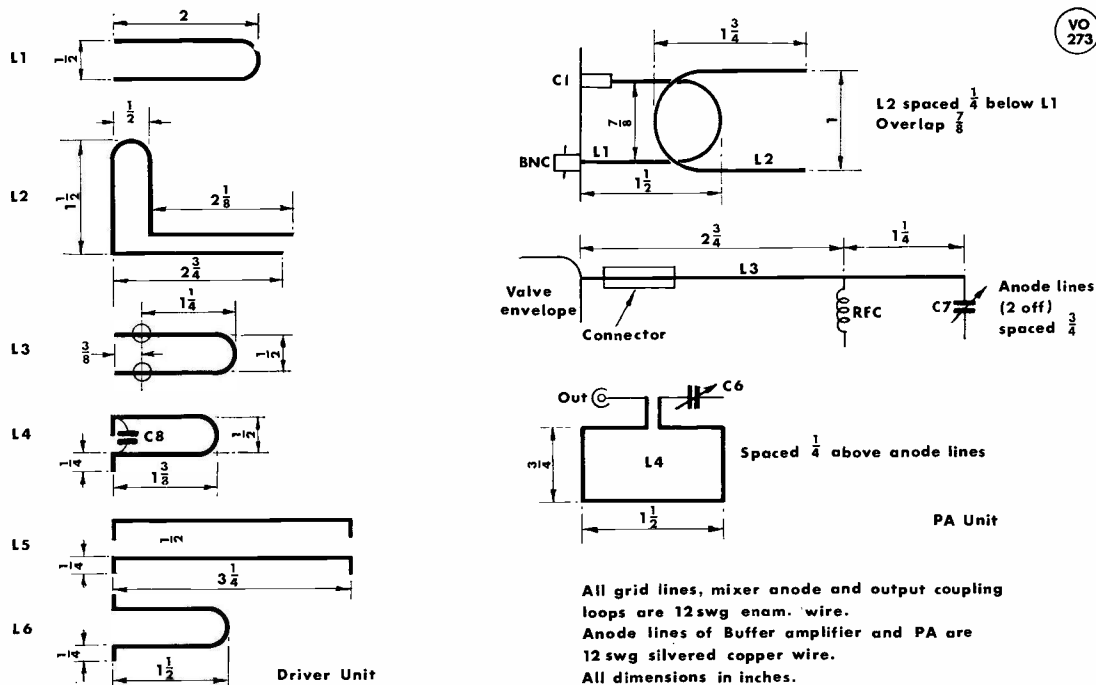

Fig. 7 Coil Data

Fig. 7. Coil data, showing configuration and dimensions

the relay contacts in the grid bias circuits are closed by the station Rx/Tx switch and the full negative rail voltage is applied to all grids thus cutting off the valves. To provide a netting signal if a separate receiver is used (and this is often desirable in contests) the double-pole switch in series with the relay contacts associated with the mixer and buffer stages is opened and operating bias applied to these valves only to produce a small signal in

the Rx. The relay connections are shown in Fig. 6.

### Conclusion

Two models of this transverter have been constructed by different individuals and both worked first time. It would appear, therefore, that the design is repeatable provided that all the usual precautions associated with VHF circuitry and wiring are taken.

## DISCUSSING THE MFJ CWF-2 FILTER

### FOR CW OPERATION

THE MFJ Enterprises Model CWF-2BX CW Filter is one of these add-on devices intended to improve the owner's station for a particular purpose—in this case to provide an extra degree of selectivity for CW operation with a receiver designed mainly for SSB use, or with the popular SSB transceivers.

It was realized that the box is basically just an audio filter, and there were doubts as to whether it would prove worthwhile. It was arranged that we should have a production-line specimen, as supplied to customers. When it arrived it was realized at once that we had

indeed got one picked at random—there was a bow in the upper surface of the case, and the black screen-printing on the front and rear faces of the chassis were both smudged! A PP3 battery was sent along with the unit. The battery is fitted into a Terry-type clip, and the printed-circuit board is glued into the case, rather than being fixed in any more conventional way; this may raise a little problem when it comes down to servicing the filter electronics.

### The Circuit

Circuit-wise, the arrangements are for a total of four active filters in cascade, components being selected to ensure that each stage peaks on the same frequency. One of the nicer things about this method is that the effective "Q" of the filter sections can be kept down to as low as 4, which means that this audio filter is one that does *not* ring every time it gets a good signal bang "on the nose." This alone differentiates the MFJ device

The MFJ CW Filter, with necessary attachments, and (below) the circuit diagram.

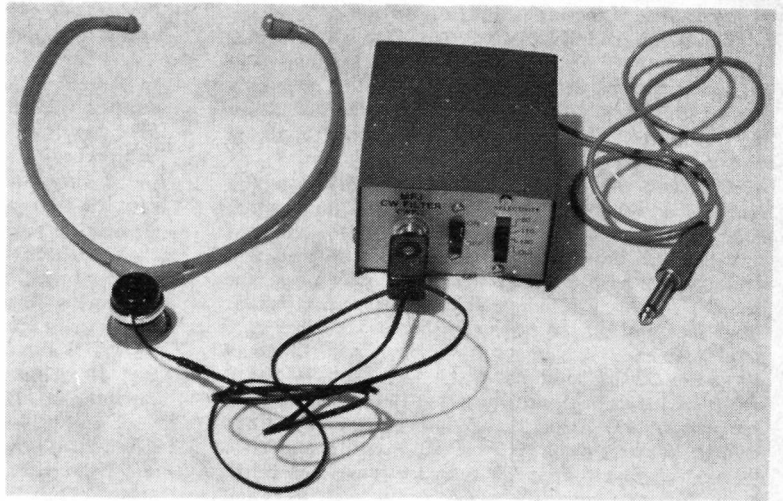

from the popular FL8 filter, or the one installed in the Eddystone 888, or indeed any of those using high-Q tuned circuits to generate the filtering.

Does it work? Sure, it works just like they say it does, with a centre frequency a little below 800 Hz. That does not say anything we couldn't have guessed! So, what about the way it works "on the job"—the hardest criterion any filter could be asked to meet.

To find out, it was tested with an Eddystone 888, a Codar CR-70A, and the station main receiver, a KW-2000B fitted with the VFO-4B adaptor and Codar Q-Multiplier. Each have headphone output sockets and so the move in each case was to just plug the output from the receiver into the MFJ filter at the terminals provided, using screened lead; the ground and signal terminals are very clearly marked so no difficulty should be raised there. Then the shack headphones were plugged into the jack at the front of the MFJ filter.

**Results**

The only word that can be used about this filter once it is plugged in is *marvellous*. Of course, one needs to use selectivity so late in the receiver chain with care to avoid overload or blocking effects at the front-end of the receiver; but having said that the results are still

quite marvellous. For example, one can go right into the sidebands of one of these big fat interlopers on, say, Forty, and copy a DX CW signal right through it—a signal which is all but inaudible, appearing on the KW-2000B alone just as blips of tone when the BC station stopped for breath, but perfectly R5 through the MFJ filter. Adding the Q-Multiplier to the recipe made some further improvement, although of course, when the Q-Multiplier is in circuit one has to be careful always to use the correct sideband when on CW, a question that

**Table of Values**

C1 = .01 $\mu$ F	R4, R7,
C2, C3,	R10, R13 = 24,000 ohms
C4, C5,	R5, R8,
C6, C7,	R11, R14 = 1.8 megohm
C8, C9 = .001 $\mu$ F	ML1,
C10, C11 = 5 $\mu$ F, elect.	ML2,
R1, R6,	ML3,
R9, R12 = 680,000 ohms	ML4 = Micrologic
R2, R3,	$\mu$ A-747

Notes: Capacitors C2-C9 and resistors R1 and R4-R11 must be selected by test for same centre frequency. ML1-ML4 are Op. Amps. S1 is single-pole four-way.

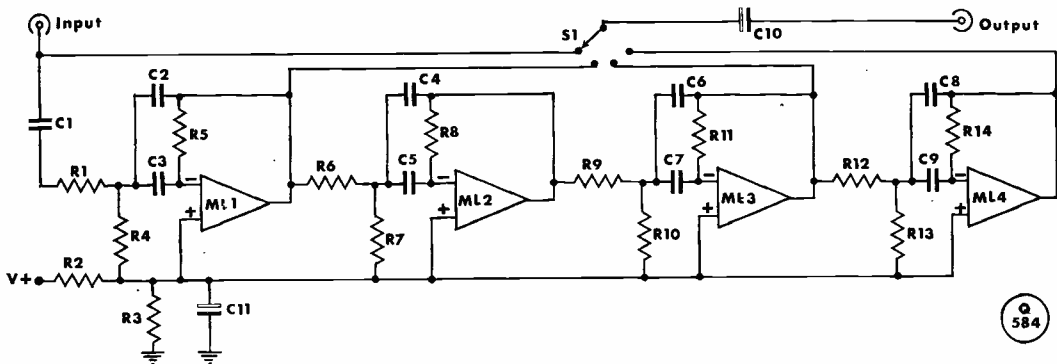



does not arise if the MFJ filter is used alone.

The device comes in two forms: One, for use outboard as outlined here, and the other for building-in to the inside of the station receiver—but for this reviewer's money, keeping it in the "outboard" form has the advantage that it doesn't disappear when you come to sell the rest of the receiver!

The test was repeated with the Eddystone 888 receiver, and here the contrast between the built-in filter in the receiver and the outboard MFJ unit was very marked; the internal filter rang violently so that while it gave an apparently sharp selectivity curve, the output was all but unreadable, while under similar conditions and on the same signal, the MFJ box gave good clean easily-read copy. If anything, the Eddystone-plus MFJ combination was better than the KW-2000B on the LF bands, but once one got to 14 MHz and above, one immediately found the slight tendency of the 888 to drift between overs to be a mild embarrassment—although many old-time CW operators have coped with worse drift to recover their QSO's after each over and thought nothing of it. In fact, so long as one is operating within a system which lets the receiver monitor the outgoing signal, then one will cope with the problem quite automatically as one "tweaks" the receiver while sending, as long as you are working single-channel.

For split-frequency working the drift of the receiver would be embarrassing.

As for the Codar, one would never expect this Rx to be used as part of a transmitting station, and so the receiver was simply tried as an SWL device with the MFJ filter in the headphone lead. Here again the little box proved to be well worth its keep, although with this sort of simple receiver, one needs to use *any* control with care, lest the signal you are after just disappears out of the receiver pass-band, let alone the filter's.

The shack headphones are high-impedance, of the "stethoscope" variety, and so it was felt that a test with a low-impedance pair would be a good idea. A low-impedance stereo set plugged in—these have a DC resistance about 15 ohms—and they were found to work just as well as the high-impedance phones giving, if anything, a little more output.

Don't be fooled by the appearance or the size of the CWF-2. If you ever operate CW, this is one gadget you ought to have permanently around, either the plain board plugged permanently into and inside the receiver if you prefer to take your stuff on the speaker, or as an outboard unit if you prefer copy through the headphones.

The MFJ CW Filter, of American origin, is obtainable through Waters & Stanton, Hockley, Essex, as advertised in these pages.

## BUILDING THE VENUS SS/TV MONITOR

### SOME PRACTICAL NOTES ON A COMMERCIAL DESIGN

P. BURNETT (G4BLL)

SS/TV enthusiasts will have noted that the *Venus SS2 Monitor* is now available in kit form, for home construction. The writer, having been interested in SS/TV for some time, and having spent most of his free hours building and then trouble-shooting a Monitor described in the small booklet published by the B.A.T.C., decided that the time had come to invest in a Monitor with rather more sophisticated circuitry, to give improved noise immunity and weak-signal handling capability.

Accordingly the journey was made to Matlock to the premises of a well-known purveyor of the equipment and the writer became the proud owner of a box full of plastic bags containing "goodies" of all shapes and sizes. The first job on opening the box was to resist the temptation to unpack everything and get started. Instead both the operating and assembly instruction manuals were carefully studied and it was a great pleasure and relief to find that every stage of construction was described in great detail.

There are eight distinct stages of construction, in the following order:—

- (1) Assembly of the front panel controls to the small printed circuit board,
- (2) Assembly of the phono sockets to the rear panel,

- (3) Wiring of sub-assembly 2,
- (4) Cable harness wiring (a further stage of sub-assembly 2),
- (5) Assembly of the front panel and CRT,
- (6) Assembly of components to the main printed circuit board, and final assembly to form the finished unit.

For further clarification the instruction manual is supported by detailed drawings of each stage. The manufacturers obviously intend that the kit should be capable of being built by the most inexperienced of constructors.

Most of the components are packed individually, and each bag is fully identified with its contents—if some components *appear* to be missing, check the packaging for the next sub-stage (the writer found several resistors missing which were later found packed along with the IC's and transistors).

Both the main printed circuit board and the front panel control board are of high quality glass-fibre construction, and it is essential that components are soldered, using a low-wattage iron fitted with a "pencil" bit. This proved to be entirely adequate for all joints on the main p.c. board (with the exception of the soldering of the screw-heads where a 50 watt iron was used). As both boards are double sided, it is essential that solder is allowed to run through so that a good joint is made on both sides. Difficulty should not be experienced in soldering any components as there is plenty of room available even in the latter stages of assembly, and all or most of the component positions are actually marked on the board.

The writer did spend some time trying to locate C49 where this was not marked on the board; this could

have been avoided had the Addendum Sheet and drawings been studied a little more closely, as this "C49" is a later addition to the circuitry. There are ten modifications listed on the Addendum Sheet, most of which are of a minor nature—but be sure to study this sheet prior to commencing assembly. Because there are a number of modifications is no reflection on the quality of the instrument, since this is a quite normal and desirable state of affairs where a Company is continually progressing and updating its products.

This brings us to specific comment for each stage of construction:—

**Figure 1:** It is possible to locate the toggle and rotary switches in the wrong positions, therefore, pay particular attention to the instructions regarding orientation.

**Figure 2:** A little difficulty was experienced in tightening up the rather peculiar shaped 6-32 lock-nuts. Not having a 7/32in. spin-tight or socket wrench specified by the manual, a pair of long nosed pliers had to be used. Also, it is necessary to have a *Philips* screwdriver of the correct size and in good condition as the nuts are rather a tight fit on the screws and require a fair amount of torque to tighten them.

**Figures 3 and 4:** The wire lengths quoted were found to be a little excessive. However, start with the lengths given and trim back if necessary when the wire is in position.

**Figures 6 and 7:** See previous comments regarding C49. The manual states that each transistor, IC and resistor should be fitted and soldered at each step. However, it is better to fit all the IC's and resistors in position, then solder only one contact of each in turn until all are soldered. This method avoid excessive heat being generated internally which could damage these delicate components. Solder both sides of the board as mentioned previously.

Handle the board carefully after assembling the mains transformer and E.H.T. unit as these are both rather heavy components which can cause damage to the printed circuits through excessive flexing if the board is handled carelessly.

### Alignment Procedure

A test tape is supplied with the kit to assist in the alignment of the unit. There are some reservations with regard to the use of this but it is good enough for the initial stages of setting up.

If the instructions are followed faithfully and these few notes observed, then on switching on the unit, after the initial warm-up period, some sort of raster should be visible on the screen. Fortunately, in the writer's case everything functioned correctly from the "off", it being only necessary to carry out the final adjustments in the sequence described.

Some of these adjustments require comment as it should be remembered that this unit was originally designed for use in areas having a 60-cycle mains supply, and it is this one single factor which can cause a few

slight problems since in the U.K. we are on 50 Hz. When peaking the Sync. Detector Band Pass Filter Tuning use a 1,200 Hz test tone from an accurate audio oscillator and *not* the 1,200 Hz tone recorded on the test tape as this will not be accurate, due to the reason given above. On peaking this circuit some 4.5 volts (instead of the 3.5v. stated) was found to be present at TP6. As this part of the circuit has been subjected to modification and the monitor functions perfectly, it can only be assumed that the measurement obtained is the correct one.

Adjustment of the Free Running Horizontal Sweep frequency (R47) will be incorrect if carried out as instructed, again due to the difference in mains frequency. However, this is easily adjusted by watching for an unbroken line and "clean" picture when using the "Spack-Mark" test tape, for example.

If the Monitor is finally set up using the circle pattern from the test tape supplied, it will be found that on receiving off the air pictures a blank border will be present on the right-hand side and bottom of the screen. Final picture positioning was accomplished, again by using the Space-Mark test tape.

There is only one feature with regard to this particular design of Monitor which, to the writer's mind, is unacceptable—and that is that the CRT heaters remain on when the units is switched off from the front panel. This is going along with the current trends in consumer T.V. manufacture to provide "instant" picture at switch-on. The writer intends to modify this at the first opportunity so that when the knob on the front panel points to "off", it means exactly what it says.

A desirable modification would also be to have the filter in front of the CRT screen removable to enable colour picture experiments to be carried out.

It is hoped that the would-be constructor will find these few notes of some little help, and if the same pleasure as experienced by the writer is obtained from the use of equipment well designed and built, then the effort is well rewarded.



" . . . . not the throttle, the IRT control on this rig . . . . "

## FM Frequency Allocations

NEWCOMERS to the FM scene on 144 MHz may be unaware of the Channel Number system which is in wide-spread use in this country and on the Continent and is used to indicate certain simplex and repeater frequencies. Let us look at the latter first. Repeater *input* channels are distinguished by the prefix "R" followed by a number between 1 and 9 and are spaced at 25 kHz intervals between 145-025 MHz and 145-225 MHz. Thus, Channel R1 is 145-025 MHz, R2 is 145-050 MHz and so on. These represent the *input* frequencies of various repeaters. The *output* frequency is, in every case in this country, 0.6 MHz higher. As an example, GB3PI on R6 which means that the *input* frequency is 145-150 MHz and the *output* on 145-750 MHz. GB3LO is on R7, the *input* being on 145-175 MHz and the *output* on 145-775 MHz. GB3MH, the Malvern Hills repeater is on R7, GB3BC in the Bristol Channel area on R6 and GB3SN on R5.

Repeater *output* channels are given the prefix "S" followed by a number lying between 25 and 30 and are spaced at 25 kHz intervals up the band from 145-625 MHz to 145-825 MHz. They are related to the repeater *input* frequencies in that they are 0.6 MHz higher in each case. Thus, Channel R1 on 145-025 MHz is linked with Channel S25 on 145-625 MHz, Channel R2 on 145-050 MHz links with Channel S26 on 145-650 MHz, and so on. It may be noted here that 145-000 MHz bears the designation R0 but by common consent is used as an international mobile calling channel and will not be used for repeater operations.

The FM simplex channels lie between 145-500 MHz and 145-600 MHz, carry the prefix "S" followed by a number between 20 and 24, and are spaced at 25 kHz intervals within these limits. Thus, S20 is on 145-500 MHz, S21 on 145-525 MHz and so on. Since there is no supra-national decision on the use of these frequencies, their allocation for specific purposes varies throughout the country, but in the South a pattern seems to be emerging which puts S20 as the national mobile calling channel, and S21 to S24 as working channels, the implication being that, once a contact is established on the calling channel, it should be followed by a rapid QSY to S21 to S24.

There has also been a proposal in some quarters that S21 to S24 should be linked to the geographical Zones which were adopted as part of the last Band Plan. Thus, S20 replaces 144-48 MHz as a national mobile calling channel; S21 instead of 144-40 MHz as the Zone "A" working channel; S22 replaces 144-80 MHz and becomes the Zone "B" working channel; S23 instead of 145-20 MHz as the Zone "C" working channel and S24 replaces 145-60 MHz as the Zone "D" channel. However, these allocations have not by any means been universally adopted, and considerable use is made of 145-60 MHz in the North of England and in Scotland as a calling channel.

Finally, the following allocations have been made for repeaters "in the pipe-line"—GB3PO, Martlesham Heath; R3; GB3NA, Barnsley, R3; GB3CS, Forth/Clyde, R6; GB3HH, Buxton, R4; GB3ND, Bacton (Norfolk), R2. Other repeaters will be fitted into this pattern, the selection of channel depending mainly upon propinquity and radiation pattern overlap to avoid mutual interference.

# VHF BANDS

A. H. DORMER (G3DAH)

## Contests

Reports: Opinions appear to be sharply divided when reporting propagation conditions for the two-metre contest at the start of March. GD2HDZ, for example, assessed them as reverting to sub-normal and found it a struggle to get his 105 contacts in spite of the attractive call sign and the "two for the price of one" factor. Conditions in Northern G and GM were described as atrocious and several reports from the West Country suggest that, whoever else was having a ball, they were not. G13JLA, none other than our old friend EI6AS, worked nine other GI stations on SSB, so activity was there, but little seems to have been heard of them beyond the NW coast of England. Unfortunately, your scribe could not get on for this event, but local reports indicate that things were not too bad—G8BQX/P in Sussex for example, made over 400 contacts including a fair bag of Continentals, and G3MOT (Oxon.) worked five GM on the trot. The Welsh portables seemed to be finding the activity—GW3UCB/P for instance made 509 contacts, 176 of them in the first three hours! It seems undisputed that propagation was better on the Saturday than the Sunday, particularly as far as Continental activity was concerned. There was quite a bit of contest activity on the mobile calling channel, 145.50 MHz, which ought *not* to have been there, and even the FM mobile working channels were pretty clogged at times. As they stand at present, contest rules do not proscribe this, but do bar contest working through repeaters. Results: 1296 MHz Cumulatives. G3JVL (Hayling Island) carried this off fairly easily with G6XM (Swindon) in second place. Several contestants made the point that these affairs should be timed to coincide with the evening lift period and this must surely be supported by regular users of the band. There is a significant enhancement of signal strengths after 2300z when the upper atmosphere has had time to cool down, which would add considerable interest to the event, and a couple of latish sessions a month for a short period are unlikely to deter those keen enough to come on the band in the first place. These remarks are equally applicable to 70 cm.

432 MHz Cumulatives. A disappointingly small entry for this event but, with the exception of the second session, conditions were pretty poor and many operators may have felt it useless to send in logs. Perhaps the answer is to have only one such Cumulative contest per year, and that in the summer when conditions are likely to be at peak. G3NHE and GD2HDZ were joint winners.

70 MHz Cumulatives. G3NHE carried off this event also and was followed by G3UKV/P, who topped G3XBY by two

points only. The 20 entries are a reflection of the increasing interest in this band, particularly SSB operation, but for many, seven sessions were too many.

Forthcoming Events: April 5/6 are the dates for the 70 MHz Open and SWL contest; April 27 for the 23 cm. Open and May 4 for the 432 MHz Open and SWL. The annual "G2CJN VHF Contest" organised by the Grafton Society takes place on May 3 between 2100z and 2400z and is open to all licensed amateurs. (*not* to Clubs). Further information from the contest secretary, G3ZKE, QTHR.

## Repeaters and Beacons

The rate of licensing and commissioning of repeaters seems to have slowed down somewhat recently, but at last we have GB3LO on the air. After running in the beacon mode for some days the repeat facility was activated and considerable use is now being made of it. It has its teething troubles—the Low/High signal does not appear to be operating as it should (at March 10) and it would appear that the discriminator circuitry generating these indications is working too close a tolerance, since stations measured at only 1 kHz away are recipients of this reproof. Not that it appears to make the slightest difference to them in many cases! Intermittent impulse noise appears on the output channel from time to time which is not audible on the input channel and which only appears when modulation is present, and this is being investigated now.

Inevitably, newcomers to this mode of operation are finding it a bit difficult to get the hang of things—not waiting for the "K bleep" before transmitting is one catch, over-running time and over-deviation are two others. Inevitably also, there is a fair amount of indiscipline, due more to ignorance than intent, and not at all helped by the high level of activity. Perhaps "a G3VEH" in the London area could straighten things out to the same high level as he has in Cambridge! Just to remind you—input is on 145-175 MHz and output on 145-775 MHz and the access tone is 1750 Hz.

Several member countries of IARU Region 1 have sponsored a suggestion that 2m. beacons should be moved to around 144-90 MHz, 70 cm. beacons to the 432-90 MHz area and 23 cm. beacons to around 1296-90 MHz. Now this seems a very sensible idea since it would remove many of the present objections to having strong, static transmitters in a sub-band at present extensively used for CW and SSB DX working. Certain beacons, such as SK4MPI for example, are used for quite separate scientific studies and would benefit from QRM-free channels. Everyone seems to be in favour of beacons, except when they are sited on the doorstep, and a move to comparatively quiet parts of the bands would overcome this objection. This proposal, with which this Column concurs, is to be discussed at the Warsaw Region 1 IARU Conference on April 14 and, although the notice is rather short, readers' views would be most useful if they could be sent in before April 7.

## VHFCC Awards

We are very pleased to welcome to the ranks of the Century Club this month G13HXV for Belfast, doubly so in fact, because not only do we get but few claims from Northern Ireland, but also because his

Award No. 8 is for operation on Four Metres. Although licensed way back in November, 1952, 'HXV did not come on Four until mid-1961 using, at that time, an SCR522 (takes you back a bit doesn't it?) for CW/AM with a xtal-controlled converter and an Eddystone 640 receiver with a 4-ele. beam. This set-up was used for several years and later a Nuvistor pre-amp was added to an updated converter with an E88CC in the front end. At this time, all the HF gear was disposed of and activity geared exclusively to 4m., and this included mobile working with a B44. The latest rig consists of a solid-state Rx with CC converter with pre-amp. for 4m. and a mosfet converter for 2m. The antennae are a ground-plane for 4m. and a crossed dipole arrangement for 2m.—a beam replacement is on the way. The 4m. Tx is home-built, incorporates a transistorised modulator and runs 30 watts input on CW/AM. A "Cambridge" in the car boot supplies the RF for 4m. and a Vanguard is used for CW/AM on 2m. This claim includes some mouth-watering DX and such important "First" on 4m. as GI/G, GI/GM, GI/EI, GI/GD and GI/GW. Congratulations, and let us hope that this Award will stimulate some more 4m. claims—from anywhere!

Now for two metres: First claim this month came in from Alan Pullen, G8BXJ (Bristol) who gets Award No. 234. He opened up on the band in October, 1968 and is now running a TS-700 to a pair of 10-ele. crossed Yagis. He is also active on 70 cm. with a FT-2FB into a varactor tripler and 46-ele. Multibeam (FM only) and on 23 cm. using the 70 cm. Tx and a *Micro-wave Modules* varactor tripler, his first contact being made in February of this year.

G8FOW operates from Sutton Coldfield and gains Award No. 235. He runs 25 watts of A3 from a Murphy "base station" and uses an EC-10 with *Sentinel* converter for reception. The site for the 8-ele. Yagi is at 600ft. a.s.l. but the take-off to the South is still poor.

Now to Roy Andreang, G4CMT of Hull. His Award is No. 236. He runs a Pye "Vanguard" with 32 watts of AM but has recently acquired a Liner and found the going much easier—as most people do when they change to SSB operation—and got his 100 QSL cards within four months. He also operates mobile and portable with this gear. Apart from the HF bands, for which he has full coverage, Roy is on 4m. with a converted "Cambridge" running 5 watts out to a 3-ele. Yagi and multiplies up from the Vanguard to get about 4 watts of RF into a 46-ele. beam on 70 cm. He has the distinction of being the only amateur to operate from the top of the Humber Bridge Tower, and this on his 50th birthday, too! He went up in the lift with the workmen and made 26 QSO's in 25 minutes (on Top Band). At 485ft. up, this should be a good site for VHF/UHF portable work, although getting a generator and all the gear up there might present a bit of a problem!

Finally, to GM4CXP of St. Boswells, Roxburghshire. Derrick Dawce gains Award No. 237 and must be congratulated on getting the 100 QSL's in under one year from commencement of operations on 2m. in March 1974. Most of the contacts were made with the Liner, with just a handful on 10 watts of AM. He has modified the Liner for CW, and uses a dual-output converter feeding an FR-50B to give him split-working facilities over the whole of the band. He is also

on 70 cm., running the Liner into a tripler to yield 5 watts of CW into the 46-ele. beam on 432.30 MHz, and on 4m. on Sunday mornings on fixed frequencies of 70.26 MHz and 70.32 MHz on CW.

So that's it for this time. We should particularly welcome claims for bands other than Two to stimulate activity where it is most needed.

#### The View from GM

Several reports are to hand commenting on the excellence of the early February openings. As here in the South, the best contacts seem to have been with the Scandinavian and N. German stations, with the DLØPR beacon on 144-140 MHz providing a splendid indication of propagation in that direction for days on end.

Scanning the latest reports, the impression is strengthened that these openings were much more useful in GM than in England. GM3VFB and GM3COX, operating portable from Tomtain (QRA XQ80d) on February 9, knocked up a massive tally of SM, OZ, PA and DL SSB contacts from their 1500ft. a.s.l. site between 1130z and 1730z. Signal strengths varied between RS57 and RS59+ both ways. The gear used was a Liner with an 11-ele. Yagi. An interesting feature of this operation was the localised ducting which they observed, the target area being an arc about 950 km from the site, 25° wide and bearing from 085°E to 110°W. Two good N/S contacts were those made by GM8FFX of Aberdeen with G3AWZ in Somerset and G8IWD/P in Dorset. 'FFX has already made 700+ QSO's with stations

THREE-BAND ANNUAL VHF TABLE  
January to December, 1975

Station	FOUR METRES		TWO METRES		70 CENTIMETRES		TOTAL Points
	Counties	Countries	Counties	Countries	Counties	Countries	
G3DAH	24	2	41	6	26	7	106
GD2HDZ	15	2	44	9	21	5	96
G3ZMD	19	1	43	8	17	3	91
GM8FFX	—	—	69	14	—	—	83
G3FIJ	25	1	36	8	2	2	74
G3BHW	—	—	38	9	19	7	73
G3BW	—	—	48	10	10	3	71
G4BWG	13	1	47	9	—	—	70
G4BYP	18	3	40	8	—	—	69
G4CZP	—	—	53	13	—	—	66
G8FMK	—	—	26	2	25	4	57
G8EOP	—	—	34	11	8	3	56
G8ABH	—	—	29	4	17	5	55
GM4CXP	4	2	32	10	1	1	50
G8BKR	—	—	39	6	3	2	50
GW3KGD	—	—	41	8	—	—	49
G4DNJ	—	—	41	7	—	—	48
G8FWB	—	—	41	6	—	—	47
G8GHZ	—	—	33	6	1	1	41
G4AEZ	2	1	9	7	14	4	37
G5DF	16	1	Æ	—	16	2	35
G8HII/P	—	—	30	2	—	—	32
G4AIR	23	3	—	—	—	—	26
GW8HVP	—	—	19	4	—	—	23
G13JLA	—	—	16	5	—	—	21
G3KEP	3	1	6	3	—	—	13
G4BKY	—	—	8	2	—	—	10
G4AGE	—	—	—	—	3	1	4

#### Notes:

- Claims should be on the basis of the new County organisation given on page 97 of this issue.
- The Table shows claims to date from January 1, 1975 and will close on December 31, 1975.
- All claims should be sent to: "VHF Bands," *SHORT WAVE MAGAZINE, BUCKINGHAM, MK18 1RQ* as soon as possible after the start of a new month.

## TWENTY-THREE CENTIMETRES

## ALL-TIME TABLE

Station	Countries	Countries	Total
G4BEL	28	7	35
G3DAH	22	7	25
G3JVL	20	4	24
G8ARM	20	2	22
G4BYV	16	6	22
G3COY	15	3	18
G3JXN	17	1	18
G4ALN	15	3	18
G3NHE	15	3	18
G8NOD	11	2	13
G3DF	11	1	12
G8FMK	11	1	12
G8FJG	7	1	8
G8ABH	7	1	8
G8AH	5	2	7
G8EOP	2	1	3

outside Scotland this year! GM3ZBE had a fine 70 cm. 4-way with G3LQR, G3ZEZ and PA0VZL at the end of February, although conditions in the South did not appear to be particularly good.

GM8FVC, GM8IZH and G4BTW have organised an unusual expedition for April 5, the aim of which is to operate on Two from the three highest peaks in Scotland, Wales and England. They start at midnight on April 4 from Ben Nevis, plan to be on Snaefell in I.o.M. between 1100z and 1300z on April 5 and on Snowdon at about 2100z. They will have SSB on 144-19 MHz and the special callsign GM3UKP has been applied for. "Mission Control" will be operated by GM8EUG, who will be able to keep callers advised on progress.

Outdoor 3 cm. operation, stimulated by GM3OXX *et al.*, has been severely hampered by the recent spell of bad weather, but the group are actively engaged in planning for the summer months. One certain target is the 151 km. path between Ben Ime and Cock Law. For the rest, the emphasis will be on super-refraction DX paths from sea level locations over non-optical distances. GM8OXX plans to take his gear to I.o.M. at the end of May.

GM8BZX and GM8BOW are two new converts to 2m. SSB, the former using the Limer and the latter a Multi-2000, so if you are looking for Angus . . . ?

Two-metre communication between Glasgow and Edinburgh has never been very easy, although GM5VG makes it appear to be, and GM6ZV was logged recently by GM6XI in Edinburgh at R556 when he was working into Dundee! The proposed change of frequency for the Angus beacon to around 144-95 MHz seems to have met with general approval in Scotland. At least it will release several kHz from the busy part of the band and also remove that powerful signal on 28 MHz for Oscar VII! GM3BQA has been doing very well via the satellite in Mode "A" and is reported to have developed a keen interest in 70 cm. with a view to having a go on Mode "B." (We were pleased to learn that, to the chagrin of the local undertakers and the delight of his friends, he has abandoned Hang Gliding!) Pleased also to learn that GM3BQO has recovered from a really nasty burn caused by getting his hands across the mains. He now has a hole in one finger about the size of an almond which he says matches the one in his head!

The Central Scotland FM Group Newsletter No. 10 contains a useful tip for getting on one of the 70 cm. FM channels. Obsolete 144-8 MHz xtals will come out, nominally, on 433-440 MHz, but can be pulled to 433-45 MHz which is a recognised channel. With a bit of fiddling with additional capacitors, they can also be put on 433-475 MHz and

433-50 MHz, both allotted channels.

## Radio Teletype

It was good to see in the BARTG Newsletter for March, that David Evans, G3OUF, is conducting a regular feature on RTTY on 70 MHz and up and that he, and the Group, are pressing for a decision at Warsaw on the vexed question of speeds. Whilst 45 bauds is the standard for HF operation, a mix of 45 and 50 bauds appears on VHF, availability of 50 baud machines being perhaps an important factor here. To an outsider, it would certainly seem that standardisation of speeds and frequency shifts leading to greater compatibility would be a good thing. G3OUF, QTHR, invites comments on these and allied matters.

## Dishonesty

Norman Fitch, G3FPK, feels very strongly, as does your scribe, about the growth of poor SSB signals on 2m, and the failure of some operators to give honest reports such as "You are S9+ and readability 2 due to your distorted signal which occupies 40 kHz of bandwidth" instead of "You are S9+ and really booming in." Now, this Column has often enough commented upon such signals and has suggested ways of ensuring that a clean transmission is radiated, but perhaps not enough emphasis has been placed on the necessity, if not the duty, of telling a chap that his transmission is lousy. He may not be aware of it if some fault has suddenly developed in the gear and would welcome his attention being drawn to it. He may not, or not be able to, monitor his own transmission, in which case he would be likely to welcome helpful criticism. He may even think that the garbage he is transmitting is quite acceptable. Whatever the reason, your scribe in many years of operating has never yet encountered the chap who resented honest criticism, and most operators welcome it. Shouldn't we all try to help clear up some at least of the mess?

## Attenuation

Bill Hodgson, G3BW, of Whitehaven, Cumbria finds it very difficult to get out well on 2m, and 70 cm. from his QTH except to the West and Northwest where he has a sea path into GD, GI and GM. Many years ago it was reported that radio communication in that area was "difficult" and an investigation indicated as a probable cause the high iron-ore content of the Cumbrian hills. This finding was also applicable to other areas in the country. Although this explanation is more likely to apply to the lower frequencies, it would be interesting if any other evidence, *pro* or *con*, could be adduced by readers in a similar situation, which would show if the theory was equally applicable to VHF/UHF.

## Variety

Referring to the comments last month about the AM/FM/SSB schism on Two, George Sassoon, G3JZK, points out that there is plenty of room on all our VHF bands for devotees of any of these modes as well as such *exotica* as EME, M/S, etc. so there should be little overlap of one mode to the detriment of another and no call for confining oneself to single-mode operations. Further, greater occupancy of any of the VHF bands will help to keep the commercials at bay and should be encouraged. Variety of operating modes is certainly one way of filling the spectrum and warding off interlopers.

He puts in a plea for less variety in the type of aerial used at fixed ground stations, and suggests that a standard polarisation should be agreed. There is much merit in this idea. Mobiles these days tend to use vertically polarised antennas, not just because they are aesthetically preferable to haloes but also because repeater antennae are vertically polarised. If we *all* used verticals any cross-polarisation loss would be minimised. However, most fixed stations these days are equipped with horizontally-polarised arrays which are all right for fixed station inter-operation but can cost 12 dB of loss when working many mobiles. One answer would appear to be to erect crossed Yasis and, although one must accept that one axis of polarisation can turn out to be something quite other at a remote receiving point, agree upon a standard left hand or right hand, circular polarisation. Tests have shown that there is little to choose between the results with LH or RH polarisation, provided that the same arrangement is used at both ends of the circuit, so let's stick our necks out and suggest we should follow the RH path if we are going to instal such arrays.

## Oscars

As from March 1, permission to use descending orbits of Oscar VI has been withdrawn, except for Sunday mornings.

Oscar VII predictions for April:  
April 5 Orbit 1762 Mode "A" 0753z 168-3°W.  
April 6 Orbit 1774 Mode "B" 0652z 153-1°W.  
Other orbits may be worked out as explained previously.

## News Items

Although no reports are to hand of any outstanding British contacts during the recent series of EME tests, congratulations must go to PA0SSB and VK3AKC who completed a 23 cm. EME contact on February 23.

G3LQR raised DL and PA on 13 cm. during the early February lifts. He now has his 20ft. dish working for EME exchanges. G4BYV hopes to have 23 cm. SSB available shortly using the DJ9ZR 2m. driver mixing with 1152 MHz in a 2C39A. Higher up the scale, G4BKY in Dursley, Glos., is getting prepared for 3 cm. He has klystrons, an 18in. dish and polarplexers ready.

G8GLS (Preston) is reported to have worked I2SRR in Milan on SSB on February 24. G4CXP (Carnforth, Lancs) reports a 2m. lift into France on February 21/22 and another into DL and PA on February 28. GW8GLG should now be back on the 2m. air from Dyfed and looking for contacts on 144-225 MHz between 1800-1900 each night. He has 150 watts of SSB available. G4DOJ and others are taking 2m. gear to Andorra in June. We hope that they have better luck than previous expeditions have had. As a 4m. operator perhaps he can be persuaded to approach the authorities to let him use that band also, to take advantage of any Sporadic-E which may be around at that time! It is reported that PA0VV is trying to get his permission for the use of that band for SSB/CW.

## Deadline

Deadline for the May issue is April 7, so please let us have your letters by then. Particularly, please send in your comments on the beacon proposals to reach us in good time. The address remains:—"VHF Bands," SHORT WAVE MAGAZINE, BUCKINGHAM, M18 1RQ. Cheers for now and *vy 73 de G3DAH.*

## COUNTIES OF THE BRITISH ISLES

ENGLAND		Berwickshire	<i>Brwk</i>
Avon	<i>Avn</i>	Buteshire	<i>Bute</i>
Bedfordshire	<i>Beds</i>	Caithness	<i>Cthns</i>
Berkshire	<i>Berks</i>	Clackmannanshire]	<i>Clack</i>
Buckinghamshire	<i>Bucks</i>	Dumfriesshire	<i>Dumf</i>
Cambridgeshire	<i>Cambs</i>	Dunbartonshire	<i>Dunb</i>
Cheshire	<i>Ches</i>	East Lothian	<i>E Loth</i>
Cleveland	<i>Clev</i>	Fifeshire	<i>Fife</i>
Cornwall	<i>Corn</i>	Inverness-shire	<i>Inv</i>
Cumbria	<i>Cumb</i>	Kincardineshire	<i>Kinc</i>
Derbyshire	<i>Derbs</i>	Kinross	<i>Kinrs</i>
Devon	<i>Devon</i>	Kirkcudbrightshire	<i>Kirk</i>
Dorset	<i>Dors</i>	Lanarkshire	<i>Lan</i>
Durham	<i>Dur</i>	Midlothian	<i>Mlthn</i>
Essex	<i>Esx</i>	Morayshire	<i>Mry</i>
Gloucestershire	<i>Glos</i>	Nairnshire	<i>Nrn</i>
Greater London	<i>GL</i>	Orkney Island	<i>Ork</i>
Greater Manchester	<i>GM</i>	Peeblesshire	<i>Pbls</i>
Hampshire	<i>Hants</i>	Perthshire	<i>Prth</i>
Hereford and Worcester	<i>H &amp; W</i>	Reufrewshire	<i>Renf</i>
Hertfordshire	<i>Herts</i>	Ross and Cromarty	<i>Ross</i>
Humber-side	<i>Humb</i>	Roxburghshire	<i>Rox</i>
Isle of Wight	<i>IOW</i>	Selkirkshire	<i>Selk</i>
Kent	<i>Kent</i>	Shetland Islands	<i>Shetd</i>
Lancashire	<i>Lancs</i>	Stirlingshire	<i>Stir</i>
Leicestershire	<i>Leics</i>	Sutherland	<i>Suth</i>
Lincolnshire	<i>Lincs</i>	West Lothian	<i>W, Loth</i>
Merseyside	<i>Mers</i>	Wigtownshire	<i>Wig</i>
Norfolk	<i>Nflk</i>		
Northamptonshire	<i>Northants</i>	NORTHERN IRELAND	
Northumberland	<i>Northld</i>	Antrim	<i>Ant</i>
Nottinghamshire	<i>Notts</i>	Armagh	<i>Arm</i>
Oxfordshire	<i>Oxon</i>	Down	<i>Down</i>
Salop (Shropshire)	<i>Salop</i>	Fermanagh	<i>Ferm</i>
Somerset	<i>Som</i>	Londonderry	<i>Londy</i>
Staffordshire	<i>Staffs</i>	Tyrone	<i>Tyr</i>
Suffolk	<i>Sflk</i>		
Surrey	<i>Sry</i>	REPUBLIC OF IRELAND	
Sussex, East	<i>E Ssx</i>	Carlow	<i>Carl</i>
Sussex, West	<i>W Ssx</i>	Cavan	<i>Cav</i>
Tyne and Wear	<i>T &amp; W</i>	Clare	<i>Clare</i>
Warwickshire	<i>Warks</i>	Cork	<i>Cork</i>
West Midlands	<i>W Mids</i>	Donegal	<i>Dnlg</i>
Wiltshire	<i>Wilts</i>	Dublin	<i>Dub</i>
Yorkshire, North	<i>N Yorks</i>	Galway	<i>Gal</i>
Yorkshire, South	<i>S Yorks</i>	Kerry	<i>Kerry</i>
Yorkshire, West	<i>W Yorks</i>	Kildare	<i>Kild</i>
		Kilkenny	<i>Kilk</i>
WALES		Laois	<i>Laois</i>
Clwyd	<i>Clwyd</i>	Leitrim	<i>Leit</i>
Dyfed	<i>Dyfed</i>	Limerick	<i>Lim</i>
Glamorgan, Mid	<i>M Glam</i>	Longford	<i>Long</i>
Glamorgan, South	<i>S Glam</i>	Louth	<i>Louth</i>
Glamorgan, West	<i>W Glam</i>	Mayo	<i>Mayo</i>
Gwent	<i>Gwent</i>	Meath	<i>Meath</i>
Gwynedd	<i>Gynd</i>	Monaghan	<i>Mongh</i>
Powys	<i>Pwys</i>	Offaly	<i>Offy</i>
		Roscommon	<i>Rosc</i>
SCOTLAND		Sligo	<i>Sligo</i>
Aberdeenshire	<i>Abdn</i>	Tipperary	<i>Tip</i>
Angus	<i>Ang</i>	Waterford	<i>Wat</i>
Argyllshire	<i>Argl</i>	Westmeath	<i>Wmth</i>
Ayrshire	<i>Ayr</i>	Wexford	<i>Wex</i>
Banffshire	<i>Bnff</i>	Wicklow	<i>Wklw</i>

For Amateur Radio purposes, the following also score as separate counties and may be claimed as such:

Alderney	Jethou
Guernsey	Lundy Is.
Herm	Outer Hebrides
Inner Hebrides	Sark
Jersey	Scilly Is.

The two Channel Islands groups—Jersey (GC) and Alderney, Guernsey, Herm, Jethou and Sark together (all GC) also score as separate *countries*, since Jersey and the Bailiwick of Guernsey (which includes Alderney, Herm, Jethou and Sark) are in fact separate administrations, though all Channel Is. take the same prefix.

Similarly, the Isle of Man (GD) can be claimed as both county and country.

The Scottish counties (GM) will be workable as listed till December 31 this year, though the new county groupings in Scotland—"administrative areas"—came into force this April.

## THE MONTH WITH THE CLUBS

By "Club Secretary"

(Deadline for May issue: April 3)

ONCE in a while, one comes across something of wider-than-usual point in a Club newsletter, justifying some comment in this space. This month we have two such items in the Chiltern offering. Perhaps of most general interest is their way of finding-out what people in the group want, and what sort of people they are in terms of other hobbies and activities, by way of a thirty-question handout sent with the newsletter. Even if only a few members are bothered enough to answer it, the committee will have an enormous bulk of information from which, hopefully, they can improve an already successful outfit.

The second point is that the Chiltern newsletter is quite prepared to accept and print controversial letters on subjects of national Amateur Radio interest. One such, in the current *Carrier*, concerns the old Phone/CW controversy, but from a new angle. The writer feels that the universal use of SSB at Special-Event stations does not present a balanced picture of the amateur interest. As he says, the reason usually given is that "that public do not understand CW." How true that is, and how wrong is this approach! If one has a display and a station, a change to CW, with the code coming out of a speaker, will *always* bring people to a stop, as this writer has on several occasions been able to demonstrate. The reason is quite simple—speech coming out of a speaker is "old hat" to people who recall Tony Hancock on TV, and listen to portable radios or a car set. Another speaker blethering away is unlikely to bring them to a stop—but if it starts to bleat out dits-and-dahs the noise is *different* and attracts attention. And it is odd how many people can read the stuff, anyway, as was demonstrated to the writer only a few days ago when a licensed amateur colleague was amusing himself at lunch-time by testing out a home-brew IC CQ caller which, when the button was pushed, churned out a beautiful call into an audio monitor running at very low level. It brought people round it like flies round a jam-pot—even the boss came out of his office and commented on the easy copy the thing made at high speeds but didn't like the monitor's clicky output!

\* \* \*

On a more serious subject: For some time, we have been intending to comment on complaints reaching us from visiting lecturers about the off-hand way they are received at some Club meetings. In most cases, they have accepted an invitation involving a long journey, often in the dark—only to find on arrival that there is nobody to meet them, they are not properly introduced, are not offered refreshment and no particular preparation has been made for the lecture, such as some sort of dais to sit at or speak from.

At the end of the evening, they are left to grope their own way out to the car-park without even a "thank-you"—and there is never any suggestion that petrol-money might be reimbursed.

Of course, many Clubs do *not* merit a rebuke of this sort—they treat their visiting lecturers as guests and accord them all the consideration they would show a guest in their own home. (And a Club meeting is, temporarily, in the "home" of all members).

But the unfortunate fact is that certain very good lecturers will no longer accept speaking-invitations because of the cavalier way they have been treated on, not one, but several occasions at Club meetings to which they have been asked to give a talk.

And now to happier topics—the Club reports for this month.

### The Specialists

The first one to appear in this group is the G-QRP Club, which, as its name implies, caters for the many amateurs who have an interest in operating with low power rigs. The current *Newsletter* carries modification data on the HW-7, aerial tuner details and a very good article on Aerials, also reprints of various items of interest.

B.A.R.T.G. handles the interests involved with the teleprinter or teletypewriter used on the amateur bands, by way of technical articles, details of the contests run in the RTTY mode, advertisements of special interest to them and so on. Details from G3OZF, as Panel. Their annual convention takes place on May 24, at Meopham Village Hall, Kent, the general arrangements being much the same as last year.

### West Country

Quite a fat clip from this part of the world, with Yeovil in pole position. They can be found every Thursday evening at the Youth Centre, 31 The Park. On April 24 there will be a tape-lecture by G3IOR on DX Working, Aerials and Propagation.

Hereford assemble themselves into a coherent entity on the first and third Friday of each month, the venue for this process being the Civil Defence Hq., Goal Street. We are without details of the April goings-on, the *Newsletter* we have to hand not carrying the details that far forward. However, they seem, on the evidence of their past activities, to be a pretty good group.

Now Newquay, who allot alternate Wednesdays to be at Treviglas School; on April 2 they will be told how to set up a Colour Television, and on the 16th the talk will be on the useful art of Printed-Circuit Photo-Copying—they should put this one on Tape and offer it to other Clubs! April 30 rounds off the month with a talk on Model Control by Radio.

Still in Cornwall, just, we have Saltash making a welcome return to the lists after quite a long silence. G4UZ will be talking to them on April 4, and on April 17 they have a visit to the Planetarium at Plymouth Polytechnic, starting sharp at 7.45. The normal date would then be April 18, but this one is given the miss. The Hq. address is Burraton Toc-H Hall, Warraton Road, Saltash.

April 26 is the big date for Torbay if being the AGM to which all members are asked to attend. Looking on a bit to May 31, G2WS will be coming (all the way from Weston-super-Mare, incidentally) to talk about Plotting Oscar. For more details on the group, try G3UIQ, as Panel.

It seems quite a while since last we heard from the North Devon chaps, but they are still going strongly, and have just had their fifth AGM. A slight change in the arrangements is noted in that the second Wednesday in each month is at G4CG, "Crimnis," High Wall, Sticklepath, Barnstaple, while the fourth-Wednesday session is, at G2FKO, 38 Clovelly Road, Bideford; in both cases the start is timed for 7.30.

It is AGM time on April 3 for Cornish, at the SWEB Clubroom, Pool, Camborne, and they hope it will be followed for the rest of the evening by a talk on Integrated Circuits by G4CLF, of Plessey.

### Midlands Area

Inter-club activity is featured at South Birmingham by way of the first leg of a Quiz contest between them and the Bromsgrove chaps—April 2, at Hampstead House, Fairfax Road, West Heath, starting at 8.0 p.m.

At Worcester even their usually-pessimistic newsletter compiler has to admit the group is doing well—and if the reports on activities covered in his other pages are taken into account there seems to be *lots* of interesting things going on. On April 7 they have provisionally allocated time for a talk on D/F, and on the 19th they have their Construction Contest. Normal meetings are held at the Old Pheasant Inn, New Street, Worcester.

At Derby, normal Club meetings are on Wednesdays at 119 Green Lane, in Room 4. April 2 features a Surplus Sale; the 9th a talk by G8AMD on Repeaters; a Film Show is booked for the 16th; and on the 23rd there is the first D/F Practice. Finally on April 30, they will be having a "Technical Topics" discussion. In addition, the Club room is open on Monday evenings for an "Activity Night" when there are various things being done to the Hq. itself for the benefit of all, and maybe shortly a Club project if enough interest is shown.

Incidentally, the Derby chaps seem also to be doing the lion's share of the work at Nottingham too, for April! April 10 is a Forum evening, and April 24 is the AGM and presentation of trophies. The Interference talk on April 3 is by Derby's G2CVV and the Films Show on the 17th is by their G3FGY—we can only hope Nottingham return the compliment! The Nottingham Hq. is at Sherwood Community Centre, Mansfield Road.

Every Wednesday evening sees the Mid-Cheshire lads converging on Verdin Comprehensive School, Grange Lane, Winsford, where there is a "Technical Activities Centre" at the rear of Verdin Buildings. Here they have R.A.E. and CW classes from 7.30 to 8.0 p.m., when the

### PLEASE NOTE!

Closing dates for this feature for the next few months will be: April 3, May 8 and June 5. These are final dates after which material cannot be taken in but will be held over for the month following.

main activity comes on. On Easter Monday they are having an outing to Tatton Park near Knutsford, followed by a film show on April 9, and a Surplus Sale on the 16th. Converters for Seventycems is the topic for the 23rd, and at the other end of the spectrum Top Band transverters appear against April 30.

Spalding have a fine Newsletter thanks to the work of G400; and the Secretary writes in as well to tell us that they are booked in at the Ship Albion on April 4 for a Constructional Contest, while May 2 sees them at their other Hq. at the Teachers Centre, Knight Street, Pinchbeck, eliminating, hopefully, Murphy's Law from their Tuliptime Rally two days later.

April 15 is Club Night for at Solihull Manor House, High Street, for a Junk Sale; and on the very next evening a coach leaves the Civic Car Park at 7.30, headed for the "Glover's Needle" at Warndon, Worcestershire, where they have a buffet meal laid on, with nine-pin skittles against the wives and girl friends

The Cheltenham (RSGB) Newsletter nearly always has some useful snippets in it, and this time they list tinner copper wire gauges against fuse ratings for various currents between 3 and 100 amperes—ideal for hanging up over the house fuses! The chaps will be at the Royal Crescent Hotel, Clarence Street, Cheltenham on the first Tuesday in each month

Sale Moor Community Centre, Norris Road, Sale is home to the South Manchester formation every Friday; in addition the VHF and D/F interest is served by getting together on Mondays at the Club shack in Shady Lane, Manchester, 23. Reverting to the Friday affairs, April 4 sees G3TNQ discussing a Top Band Transverter, and a Club quiz fills up April 11; then G3VSA puts them wise about OSCar on April 18, and on the 25th there is a Night-On-the-Air.

The Wirral Newsletter mentions the difficulty of finding outside speakers—a topic on which we have already commented in this piece! This problem is one that faces almost all groups, and in particular those in the remoter parts of the country—like Wirral, to a

large degree, they use the talent they have within themselves. On April 2, G3UJX will be talking about the NE555/556 IC Timers, and on the 11th all cares are forgotten at the annual dinner dance. This leaves April 16 for a discussion on NFD. Hq. is at the Sports Centre, Grange Road West, Birkenhead and normally they are there on the first and third Wednesdays of every month.

#### Up North

Strange that there should be so few regular reports from this part of the world, when we know there are so many groups—perhaps the local cannibals eat their scribbles! Whatever the reason, we could use more reports from both Northern England and all of Scotland and the Isles.

Our first one almost falls in the Midland group, Bury & Rossendale, where the lads assemble at the Mosses Community Centre, Cecil Street, Bury, on the second Tuesday in each month. At the time of the report nothing had been fixed up in the way of a lecture, but there was a strong hint that something of interest was, as it were, in the pipeline to fill the gap. No doubt G8ECM would be delighted to pass on the latest information—see Panel for his address.

There was a Wigan club just after Hitler's War, but it subsequently founded; now, however, it has been brought back to life, thanks in part at least to an Hq. at Poolstock Cricket Club, in Keates Avenue. Here they have bookings on the first and third Wednesdays for a mainly social evening, and the second and fourth Tuesdays for more practical activities, these last being made possible to the building of an extension to the premises.

One is saddened to hear that G3MDW, the long-serving secretary of Northern Heights, has been out of the circuit since last April, due to personal disabilities—but he is back again stirring the gang into life at the Peat Pitts Inn, Ogdon. April 2 is the AGM, with a committee meeting on the 9th. On April 16 there is a Junk Sale with G8CB doing the honours with the hammer, and on the 30th

#### Names and addresses of Club Secretaries reporting in this issue :

ACTON, BRENTFORD & CHISWICK: W. G. Dyer, G3GEH, 188 Gunnersbury Avenue, Acton, London W3-8LB.

BARKING: J. R. Wiles, G8JEQ—address wanted.

B.A.R.T.G.: D. Beattie, G3OZF, Churchway, Stone, Aylesbury, Bucks. (0296-74 354).

BEDFORD: S. Felts, G8FMG, 6 White Lodge Close, Kempston, Beds. (Bedford 852414).

BISHOPS STORTFORD: C. Harlow, G8BTK, Thorn Cottage, Old Mead Lane, Henham, Elsenham, Bishops Stortford, Herts.

BURY & ROSSENDALE: M. Howarth, G8ECM, 11 Worthington Avenue, Heywood (65911), Lancs.

CHELTENHAM (RSGB): G. D. Lively, 131 Mandarin Way, Wymans Brook, Cheltenham (34785), Glos.

CHILTERN: F. S. G. Rose, G2DRT, 84 Cock Lane, High Wycombe, Bucks. (Penn 4240).

CORNISH: H. Webster, G3XTF, Crandale, Gillyfields, Redruth (6905), Cornwall.

CRAY VALLEY: P. F. Vella, G3WVP, 78 Hurst Road, Sidcup, CRYSTAL PALACE: G. M. C. Stone, G3FZL, 11 Liphook Crescent, London SE23-3BN. (01-699 6940).

DERBY: F. C. Ward, G2CVV, 5 Uplands Avenue, Littleover, Derby (21931), DE3-7GE.

ECHOLFORD: A. Wenham, G3ZXA, 28 Pinewood, Sunbury-on-Thames (86440), Middx. TW16-6SG.

HARROW: L. Light, G3KDL, 22 Chippinham Avenue, Wembley, Middx. HA9-6HQ. (01-902 2570).

HEREFORD: S. Jesson, G4CNY, 181 Kings Acre Road, Hereford (3237).

HULL: F. Moss, G8GDD, 334 Ings Road, Hull (76603), North Humberside.

MAIDENHEAD: E. C. Palmer, G3FVC, 37 Headington Road, Maidenhead (20107), Berks.

MAIDSTONE YMCA: G. H. Taylor, G4BNI, 26 Valley Drive, Loose, Maidstone (43976), Kent.

MID-CHESHIRE: A. Greenwood, G3SIQ, 83 Ash Road, Cuddington, Nr. Northwich, Cheshire.

NEWQUAY: B. Pearce, G8GOR, 153 Henvor Road, Newquay, Cornwall.

NORTH DEVON: H. G. Hughes, G4CG, Crinnis, High Wall, Sticklepath, Barnstaple, Devon.

NORTHERN HEIGHTS: A. Robinson, G3MDW, Candy Cabin, Ogdon, Halifax.

NORTH KENT: R. Wells, G4ARQ, 12 Bulbank Road, Belvedere, Kent.

NOTTINGHAM: S. F. Claringburn, G8HLD, 49 Fernleigh Avenue, Westdale Lane, Nottingham NG3-6FN.

G-QRP: Rev. G. C. Dobbs, G3RJV, 61 Park Street, Cleethorpes, South Humberside, DN35-7NG.

REIGATE: F. H. Mundy, 2 Conifer Close, Reigate (43130), Surrey.

SALTASH: I. Forse, G4DHA, Penlan, St. Stephens, Saltash (3219), Cornwall.

SILVERTHORN: C. J. Hoare, G4AJA, 41 Lynton Road, South Chingford, London E4-9EA. (01-529 2282).

SOLIHULL: L. G. Boswell, G4AEJ, 170 Kestrel Avenue, Yardley, Birmingham, B25-8QX.

SOUTH BIRMINGHAM: R. J. Thompson, G8GDZ, 23 Fox Hill, Selly Oak, B29-4AG. (021-472 0533).

SOUTHDOWN: A. Seabrook, G3ZQB, 6 Harebeating Gardens, Hailsham, Sussex, BN27-1JT.

SOUTHGATE: B. Oughton, G4AEZ, 48 Morley Hill, Enfield, Middx. (01-366 7166).

SPALDING: R. Harrison, G3VPR, 38 Park Avenue, Spalding, Lincs., PE11-1QX.

STAR: T. Leeman, G4BUU, 115 Asket Drive, Seacroft, Leeds LS14-1HX.

STEVENAGE: C. Barber, G4BGP, 473 Canterbury Way, Stevenage, Herts SG1-4EQ.

SURREY: S. A. Morley, G3FWR, 22 Old Farleigh Road, Selsdon, South Croydon. (01-657 3258).

SUTTON & CHEAM: A. Keech, G4BOX, 26 St. Albans Road, Cheam, Sutton, Surrey.

THAMES VALLEY: R. J. Blassdell, G3ZNV, 341 Walton Road, West Molesey, Surrey KT8-000. (01-432 2343).

TORBAY: M. Yates, G3UIQ, Top Flat, 23 Waverley Road, Newton Abbot (3025), Devon.

VERULAM: H. Young, G3YHY, 93 Leaford Crescent, Watford, WD2-5JQ.

WAKEFIELD: S. Wright, G4CPE, 8 Longfield Terrace, Batley Road, Wakefield, WF2-9PR.

WIGAN: A. Byers, G4CUF, 2 Beechwood Avenue, Ashton-in-Makerfield, Wigan (78443), Lancs. WN4-9L.

WIRRAL: H. I. Crofts, G3DLF, 3 Barmouth Way, Wallasey, Cheshire. (051-638 2515).

WORCESTER: B. A. Jones, G8ASO, 12 Woodside Road, Larkhill, Worcester (351565) WR5-2EG.

YEOVIL: D. L. McLean, G3NOF, 9 Cedar Grove, Yeovil.

YORK: K. R. Cass, G3WVO, 4 Heworth Village, York.